

Accessories Guide

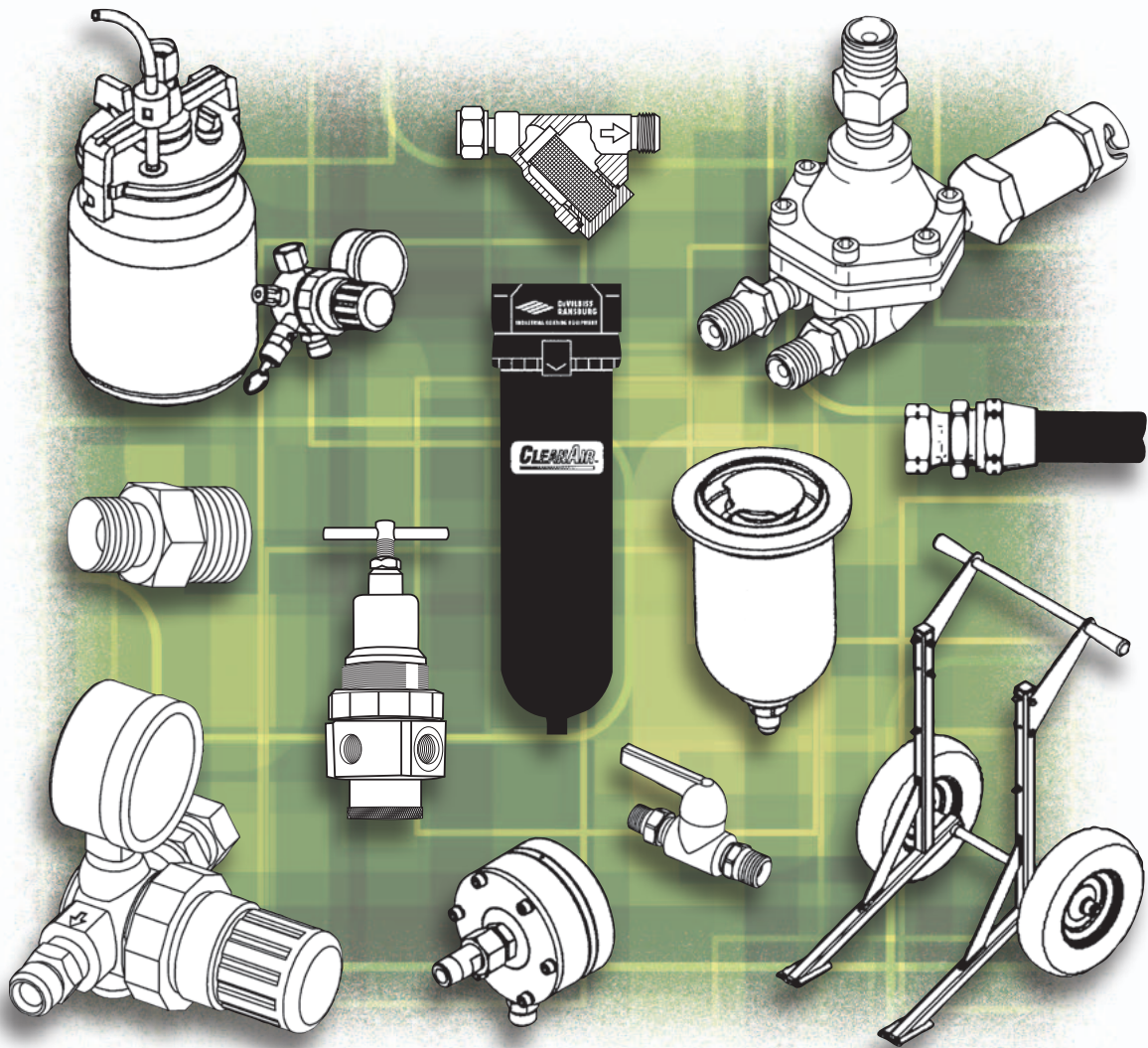

*Use genuine Binks and DeVilbiss Accessories,
Repair Kits and Replacement Parts to keep your equipment
at peak performance*

Navigating this PDF

The Table of Contents has links to each section of this *Accessories Guide*. Click on any line in the Table of Contents to jump to that page.

To return to the Table of Contents, use the included bookmark in the **Bookmarks Panel**, which can be opened by clicking the **Bookmark icon** to the left of the main window (see illustration below), or through the menu interface: **View > Navigation Panels > Bookmarks**.

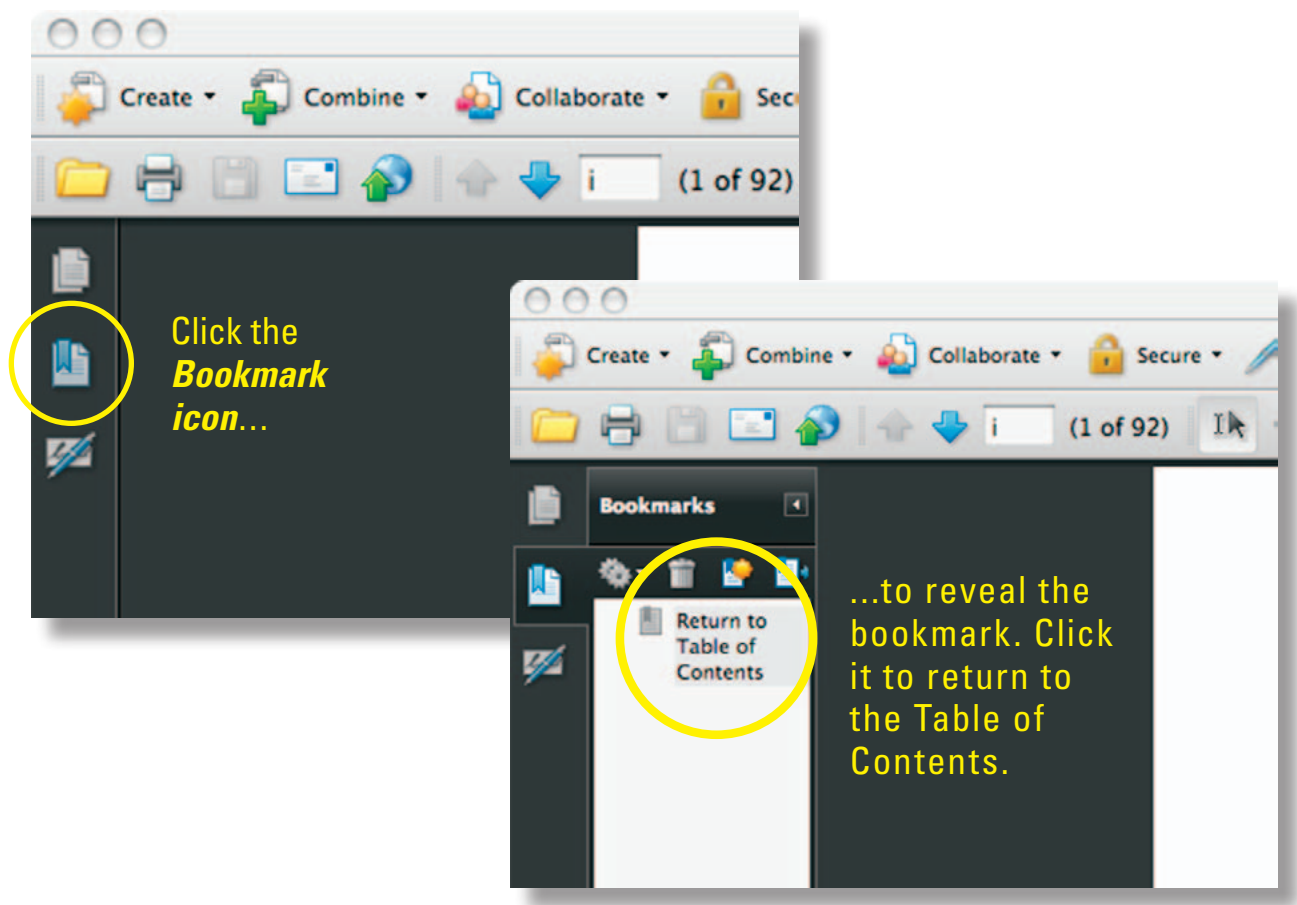

Table of Contents

1. PUMP MOUNTING HARDWARE & ACCESSORIES

| | |
|--------------------------------------|-----|
| Pump Mounting Hardware | 1-2 |
| Pump Carts & Stands | 1-3 |
| Bung Adapters | 1-3 |
| Pail & Drum Covers | 1-4 |
| Drum Elevator | 1-5 |
| Ground Wire Kits | 1-5 |
| Air Line Lubricators | 1-5 |
| Pump Protectors / Air Runaway Valves | 1-5 |
| Air Motor Mufflers | 1-6 |
| Siphon Hoses / Sets (5 & 10 Gallon) | 1-7 |
| Siphon Hoses / Sets (55 Gallon) | 1-8 |

2. FLUID FILTERS, SCREENS/STRAINERS, FILTER ELEMENTS & FILTER/SURGE CHAMBERS

| | |
|---------------------------------------|-----|
| Material Filters, Strainers, Screens | 2-2 |
| High Pressure In Line Filters | 2-3 |
| Low Pressure In Line Filters | 2-3 |
| Low Pressure In Line Y Strainers | 2-4 |
| Inlet Screens (Rock Catchers) | 2-4 |
| Gun Mounted Mini Strainer | 2-4 |
| High Pressure Pump Filter Elements | 2-5 |
| High Pressure In Line Filter Elements | 2-5 |
| Low Pressure In Line Filter Elements | 2-5 |
| Surge Chambers / Pulsation Dampeners | 2-6 |

3. FLUID REGULATORS, GAUGES & HEATERS

| | |
|--------------------------------------|------|
| Fluid Regulators | 3-4 |
| Back Pressure Regulators | 3-6 |
| Gun Mount Non-Circulating Regulators | 3-10 |
| Gun Mount Circulating Regulators | 3-10 |
| Fluid Regulator Kits | 3-12 |
| Pressure Gauges & Riser Tubes | 3-13 |
| Fluid Heaters & FRP Heater Kits | 3-14 |

4. AIR & FLUID VALVES

| | |
|--------------------------------|-----|
| Ball Valves (Low Pressure) | 4-2 |
| Ball Valves (High Pressure) | 4-2 |
| Ball Valves (Air Vent) | 4-3 |
| VA Series Valves (Air & Fluid) | 4-3 |
| Air Adjustment Valves | 4-4 |
| Pressure Safety Relief Valves | 4-4 |

5. HOSE, CONNECTIONS & ASSEMBLIES

| | |
|--------------------------------|------|
| Reusable Connections | 5-2 |
| Understanding Pressure Drop | 5-3 |
| Technical Data | 5-4 |
| Bulk Air Hose & Connections | 5-5 |
| Bulk Fluid Hose & Connections | 5-8 |
| Tubing & Connections | 5-9 |
| Air Hose Assemblies | 5-12 |
| Fluid Hose Assemblies | 5-14 |
| FRP Hose Assemblies | 5-19 |
| Catalyst Hose Assemblies (FRP) | 5-21 |

6. FITTINGS

| | |
|----------------------------|------|
| Adapters | 6-2 |
| Swivel Connections | 6-2 |
| Swivel Adapters | 6-3 |
| Swivel Unions | 6-3 |
| Reducing Bushings | 6-4 |
| Nipples & Reducing Nipples | 6-4 |
| Elbows | 6-7 |
| Misc. Connections | 6-8 |
| Tees & Crosses | 6-8 |
| Pipe Plugs | 6-9 |
| Quick Disconnects | 6-10 |
| Gun/Outlet Manifolds | 6-12 |

7. AIR SUPPLY CONTROLS & GAUGES

| | |
|---|------|
| Air Regulators | 7-2 |
| Bypass Air Regulators | 7-4 |
| Air Control Assemblies (Pumps) | 7-6 |
| Air Control Assemblies (Pressure Tanks) | 7-7 |
| Centrifugal Air Filters / Regulators | 7-8 |
| Coalescer Units | 7-10 |
| Desiccant Units | 7-12 |
| 1 Stage Charcoal Filter | 7-14 |
| 3 Stage Breathing Air Unit | 7-14 |
| 2 Stage Filter / Regulator | 7-14 |
| Filter Element Kits | 7-16 |
| Air Vizor™ Breathable Air Systems | 7-16 |
| Air Pressure Gauges | 7-17 |

8. CUPS & CUP ACCESSORIES

| | |
|------------------------------|-----|
| Siphon Cups | 8-2 |
| Pressure Cups | 8-3 |
| Gravity Feed Cups | 8-4 |
| Remote Pressure Cups | 8-5 |
| DeKups Disposable Cup System | 8-6 |
| Cup Accessories | 8-8 |
| Cup Gaskets | 8-8 |

9. SPRAY GUN ACCESSORIES & MISC. PRODUCTS

| | |
|--|-----|
| Spray Gun Cleaning Kits, Brushes & Tools | 9-2 |
| Solvent Saver (Hose Gun Cleaner) | 9-3 |
| Spray Gun & Pump Lubricants / Fluids | 9-3 |
| Spray Gun Accessories | 9-4 |
| Spray Gun Stands (Gravity Feed Guns) | 9-6 |
| Misc. Products | 9-6 |

Pump Mounting Hardware & Accessories

| | |
|--|------------|
| PUMP MOUNTING HARDWARE | 1-2 |
| PUMP CARTS & STANDS | 1-3 |
| BUNG ADAPTERS | 1-3 |
| PAIL & DRUM COVERS | 1-4 |
| DRUM ELEVATOR | 1-5 |
| GROUND WIRE KITS | 1-5 |
| AIR LINE LUBRICATORS | 1-5 |
| PUMP PROTECTORS / AIR RUNAWAY VALVES | 1-5 |
| AIR MOTOR MUFFLERS | 1-6 |
| SIPHON HOSES / SETS (5 & 10 GALLON) | 1-7 |
| SIPHON HOSES / SETS (55 GALLON) | 1-8 |

Pump Mounting Hardware & Accessories

Pump Wall Mounting Brackets

| Part Number | Pump Style | Materials of Construction | Used with Air Motor | Notes |
|-------------|------------------------|---------------------------------|--|---|
| 873184 | Infinity | Painted black carbon steel | 2", N Series and 4-1/4" | 2" npt(f) threaded hole, open 55 gal. Rim mount |
| 873115 | Infinity | Painted black carbon steel | 4-1/4", 6" 2 and 4 ball and 1" Diaphragm Pumps | Full hole cut-out |
| 873134 | Infinity | Painted black carbon steel | 3:1 Diaphragm Pumps | 4 bolt, full hole cut-out |
| 873237 | Infinity | Painted black carbon steel | 8" Air Motors | 4 bolt, full hole cut-out |
| 873116 | Infinity & Gemini 1/2" | Painted black carbon steel | N Series and 1/2" Diaphragm pumps | 4 bolt, full hole cut-out |
| 873189 | Infinity | Painted black carbon steel | 12" Air Motors | 4 bolt, full hole cut-out |
| 873461 | Infinity | Painted black carbon steel | Raptor, Vector 8122XX and 8126XX series pumps | 4 bolt, full hole cut-out, with air reg.mnt. holes |
| 41-10705 | Comet | Painted blue carbon steel | Comet 3 and 4" Air Motors | 3 bolt, v cut. Holes for air reg. kit and bpr. or fltr. |
| 207-12328 | Exel | Unpainted zinc plated steel | Exel | 4 hole for air mtr, 2 hole for mounting (2 Req'd) |
| 0114-014806 | Comet 4/12 | Painted black carbon steel | Comet 4/12 | 4 bolt, full cut hole |
| DVP-50 | DVP | Painted black carbon steel | Single Diaphragm Pump | |
| 41-28047 | BX | Powder coated blue carbon steel | B8 and B10 Air Motors | Multiple mounting holes for air mtrs, regulators & heaters, etc |
| 41-28091 | BX | Powder coated blue carbon steel | B8 and B10 Air Motors | Multiple mounting holes for air motors, regulators & heaters, etc., air control |
| 0115-010179 | MX | Painted black carbon steel | MX-4/12 MX-4/32 | Slotted bracket for wall or cart mount |

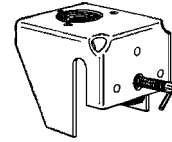

873184

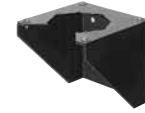

873115



873116

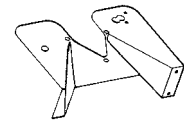

41-10705

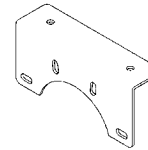

207-12328



0114-014806

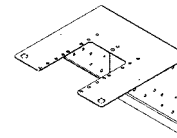

41-28047

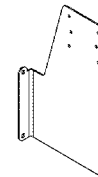

41-28091

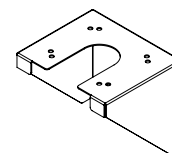

0115-010179

Pump Mounting Hardware & Accessories

Pump Carts & Stands

| Part Number | Pump Style | Materials of Construction | Used with Air Motor | Notes | Service Form |
|-------------|---------------------|---|-------------------------------------|-------------------------|--------------------|
| 873186 | Infinity | Black painted carbon steel | 4-1/4" and 6" 2 ball Infinity pumps | Large pneumatic tires | 81224x and others |
| 41-28050 | BX | Blue painted carbon steel | BX-36 and BX-57 pumps | Large pneumatic tires | 77-2902 77-2904 |
| 41-2208 | Comet | Blue painted steel bracket with chrome plated, tubular steel cart | Comet 3" and 4" 18:1 and 30:1 pumps | Semi-pneumatic tires | 77-2281 |
| 0110-011802 | Comet 4/12 | Aluminum | Comet 4/12 pumps | Tripod stand with plate | 77-5463 |
| 0114-019203 | Comet 4/12 | Black painted carbon steel | Comet 4/12 pumps | Semi-pneumatic tires | 77-5462 |
| 0115-010100 | MX 4/12 and MX 4/32 | Aluminum | Binks MX 4/12 and MX 4/32 | Tripod stand with plate | 77-2912 77-2913 |
| 0115-010186 | MX 4/12 and MX 4/32 | Black painted carbon steel | Binks MX 4/12 and MX 4/32 | Semi-pneumatic tires | 77-2912 |
| 0115-010400 | MX 4/12 and MX 4/32 | Black painted carbon steel | Binks MX 4/12 and MX 4/32 | Semi-pneumatic tires | 77-2913 |



873186

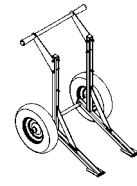

41-28050

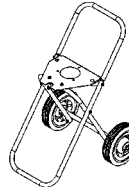

41-2208



0110-011802



0114-019203

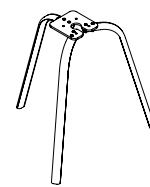

0115-010100

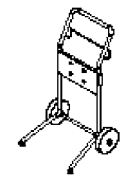

0115-010186



0115-010400

Threaded Bung Adapter

| Part Number | Materials of Construction | Notes |
|-------------|---------------------------|---|
| 873227 | Cast aluminum and steel | Threaded for 2" bung drum thread and used on Pogo series pumps. With thumb screw. |

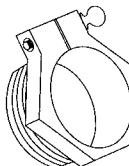

873227

Bunghole Adapter Kits

| Part Number | Materials of Construction | Notes |
|-------------|---------------------------|---|
| 41-15899* | Stainless steel | With lockwasher, set screw and locknut. For 1/2" siphon tubes (7/8" o.d.). |
| 41-15898* | Stainless steel | With lockwasher, set screw and locknut. For 3/4" siphon tubes (1-1/8" o.d.). |
| 41-15895* | Steel | With lockwasher, set screw and locknut. For 1" siphon tubes (1-11/32" o.d.). |
| 207-11692-1 | Aluminum | 1" siphon tube bung adapter. Requires 237-621 thumbscrew. (not shown; order separately) |



41-15895, 41-15898, 41-15899

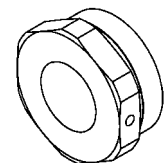

207-11692-1

*41-755 spacer and 20-2454 nut are included

Pump Mounting Hardware & Accessories

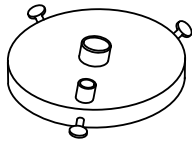

874502

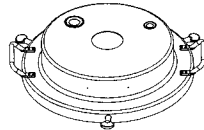

41-3205

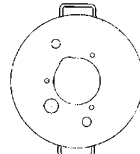

41-2455

5 Gallon Pail Covers

| Part Number | Pump Style | Materials of Construction | Used with | Notes | Service Form |
|-------------|-----------------------|----------------------------|----------------------------------|---|--------------|
| 874502 | Infinity | Stainless steel | 843000 Agitator | 5 Gal. Cover for 1/2" siphon tube. Siphon tube hole: .859" Agitator hole size: 1.745" | n/a |
| 874503 | Infinity, Gemini 1/2" | Stainless steel | 1/2" Diaphragm pumps | Has agitator hole in cover. For 5 Gal Cont. | n/a |
| 41-3205 | Binks, Comet | Zinc chromate plated steel | Agitators / Pogo pumps | With agitator holes/knockouts, pump and siphon (5 Gal.) | 77-1470 |
| 41-2455 | Binks, Comet | Zinc chromate plated steel | Comet 18:1 and 30:1 pump outfits | With agitator hole and 2, 7/8" holes for regs or return (5 Gal.) | n/a |

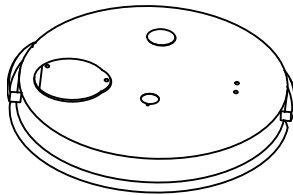

31-124

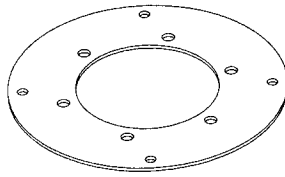

41-11499

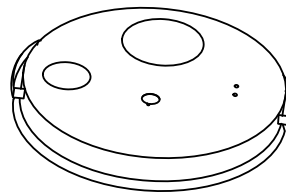

41-2414

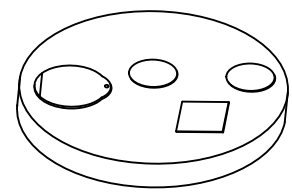

874506

55 Gallon Drum Covers

| Part Number | Pump Style | Materials of Construction | Used with | Notes | Service Form |
|-------------|-----------------------|----------------------------|---|--|--------------|
| 874506 | Infinity, Gemini 1/2" | Stainless steel | 1/2" Diaphragm pumps and bung mntd. piston pumps such as 812490, pogo pumps | With insp.port, agitator hole and hole for pump or bung mount (55 Gal.) Hole sizes: 2.406" (medium hole), 1.75" (small hole), 4" (diameter), 4.875" x 6.125" (square hole), .875" (hole for pick-up tube). | n/a |
| 31-124 | Binks, Comet | Zinc chromate plated steel | 55 Gal direct drive agitator | With insp.port,agitator hole and siphon tube hole | 77-1481 |
| 41-11499 | Binks, Comet | Zinc chromate plated steel | Comet 2.5:1 High-Vol | Used to adapt to 41-2414 55 gal drum cover | n/a |
| 41-2414 | Binks, Comet | Zinc chromate plated steel | Comet 2.5:1 High-Vol | With agitator & inspection ports (55 Gal.) | n/a |

Pump Mounting Hardware & Accessories

Drum Elevator

| Part Number | Lift Capacity | Notes | Shipping Weight | Service Form |
|-------------|---------------------------------------|---|-----------------|--------------|
| 41-9000 | 235 lbs @ 60 psi 395 lbs @ 100 psi | Comes with air control valve, 10 ft. of air tubing, mounting brackets and hardware. Floor mounting anchors and drum cover are not included. Use with 31-129 and 31-397 agitator assemblies. 35-1/8" lift height. 56-1/8" high with lid lowered. 91" high with lid raised. | 68 lbs | 77-1392 |



41-9000

Ground Wire Kits

| Part Number | Description | Notes |
|-------------|-------------------|---|
| 873067 | Ground wire Assy. | 25 ft heavy duty sheathed wire with screw type clamp on one end and large ring terminal on the other. |
| 41-13021 | Ground wire Assy. | 8 ft long 18 gauge with small alligator clamp on one end and large ring terminal on the other. |
| 0114-016243 | Ground wire Assy. | For use with Comet 4/12 pumps. |
| 0114-011798 | Ground wire Assy. | For use with MX 4/12 pumps. |



873067

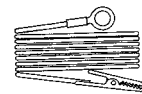

41-13021

Air Line Lubricators

| Part Number | Used on | Port Sizes | cfm Rating | Oil Capacity | Notes | Service Form |
|--------------|----------|-------------|------------|--------------|---|--------------|
| 849304 (OBS) | Infinity | 1/2" npt(f) | 110 scfm | 6oz/177ml | Metal bowl Inc. sight glass. / 175 Deg. F / 150 psi | 849304 |
| 849310 (OBS) | | | | | Lubricator connector kit | |
| 237-578 | Binks | 1/2" npt(f) | 110 scfm | 8oz/237ml | Zinc bowl Inc. sight glass. / 150 Deg. F / 250 psi | n/a |

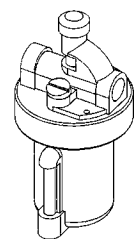

237-578

Pump Protectors / Air Runaway Valves

| Part Number | Pumps used on | cfm Range | Pressure Range | Service Form |
|-------------|---------------------------|------------|----------------|--------------|
| 41-11150 | Binks B series / Infinity | 0-150 cfm | 0-125 psi | 77-2257 |
| 41-11260 | Binks Comet | .5-4.5 cfm | 25-100 psi | 77-2416 |

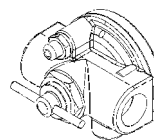

41-11150

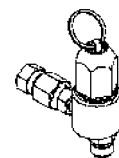

41-11260

Pump Mounting Hardware & Accessories

1



873158



873190

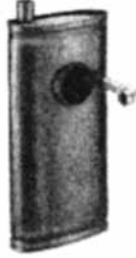

873364



873275, 873281



237-536



83-1527, 350-401

Air Motor Mufflers

| Part Number | Pump Style | Air Inlet Size | Dimensions | Notes |
|-------------|-----------------------------------|------------------|------------------------------|---|
| 873158 | Infinity 4-1/4" and 6" air motors | 1-1/4" male, npt | 3-1/2" x 11-3/16" | Used with 4-1/4" and 6" air motor pumps |
| 873190 | Infinity 8" air motors | 1-1/4" male, npt | 5-5/8" x 15-3/8" | Used with 8" air motor pumps |
| 873364 | Infinity 12" air motor | Bolted On | 9" x 20" | Used with Infinity 12" air motors |
| 873275 | Gemini | 3/8" male, npt | 2-15/16" long x 1" o.d. | Metal, 1/2" thread depth |
| 873281 | Gemini | 3/4" male, npt | 4-1/2" long x 2-3/4" o.d. | Black plastic, 7/8" thread depth |
| 237-536 | Exel / Unison Pumps | 1/2" male, npt | 3-1/8" x 1-1/4" | Aluminum, 50M stn stl screen |
| 83-1527 | Air Motor Agitators | 1/4" male, npt | 1-5/8" x 1-3/4" | Steel body, felt muffler |
| 350-401 | Air Motor Agitators | 1/4" male, npt | 1-5/8" x 1-3/4" | Steel body, felt muffler |
| DVP-17 | DVP Pumps | 1/4" male, npt | 9mm x 23mm (5mm long thread) | Bronze fritte |

Pump Mounting Hardware & Accessories

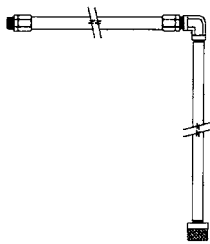

874500

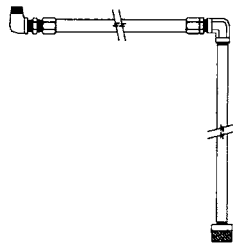

874504

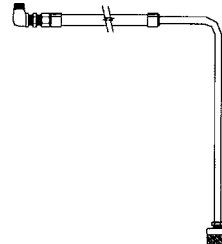

874509

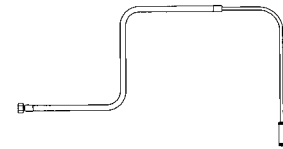

41-17237, 41-17238

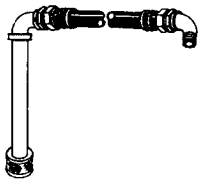

103-1093

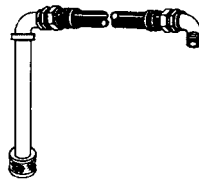

44-350



41-2294, 41-2296

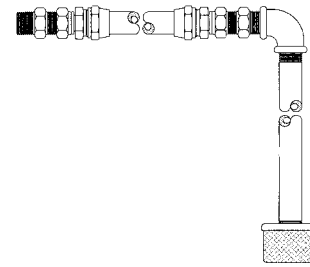

135-83

Siphon Hoses / Sets (5 & 10 Gallon)

| Part Number | Pumps Used with | Hose Size i.d. | Tube Size | Fitting Size | Siphon Hose Length | Included Screen (Mesh) | Container Size | Wetted Parts | Service Form |
|--------------|---------------------------|----------------|----------------|------------------|--------------------|------------------------|----------------|---------------------|---------------------------------|
| 874500 | Infinity | 1" | 3/4" x 16" | 3/4" male, npt | 5' | 30 | 5 Gallon | Stainless steel | n/a |
| 874504 | Infinity | 1/2" | 1/2" x 16" | 1/2" male, npt | 5' | 30 | 5 Gallon | Stainless steel | n/a |
| 874509 | Infinity / Raptor | 1/2" | 1/4" x 19" | 1/2" male, npt | 5' | 30 | 5 Gallon | Stainless steel | n/a |
| 41-17237 | Comet 4/12 | 3/8" | 3/8" x 13-5/8" | m25 x 1" (m) | 3' | 50 | 5 Gallon | Stainless steel | 77-5461, 77-5462, 77-5463 |
| 41-17238* | Binks MX-4/12 & MX-4/32 | 3/8" | 3/8" x 13-5/8" | 1/2" female, nps | 3' | 50 | 5 Gallon | Stainless steel | 77-2912, 77-2913 |
| 103-1093 | Binks / Comet | 1" | 1" x 16" | 1" male, npt | 5' | 8/16 | 5 Gallon | Aluminum, steel | 77-2126 |
| 44-350 | Binks / Comet | 3/4" | 3/4" x 17" | 3/4" male, npt | 5' | 8 | 5 Gallon | Stainless steel | 77-2098 |
| 41-2294 | Binks / Comet | 3/4" | 3/4" x 16" | 3/4" male, npt | 5' | 30 | 5 & 10 Gallon | Aluminum, steel | 77-2098 |
| 41-2296 | Binks / Comet | 1" | 1" x 16" | 1" male, npt | 5' | 30 | 5 & 10 Gallon | Aluminum, steel | 77-2098 |
| 135-83 (OBS) | Infinity Vector DVP Pumps | 1/2" | 1/2" | 1/2" female, nps | 42" | 30 | 5 Gallon | Plated brass, steel | 77-2098 |
| DVP-41-W | Binks DVP Pump | | 13-5/8" | | 3' | 30 | 5 Gallon | | 77-2870 |

*Requires adapter 0115-010235 for MX-4/12 and MX-4/32.

SEE PAGE 2-4 FOR REPLACEMENT INLET SCREENS

Pump Mounting Hardware & Accessories

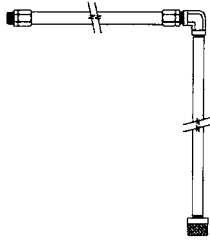

874501

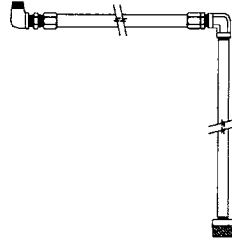

874580

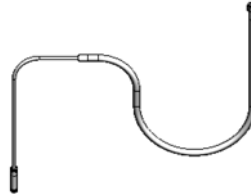

41-17233

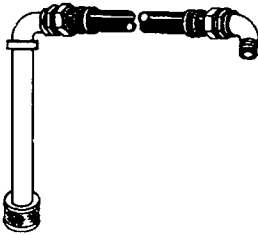

41-2616, 41-10467

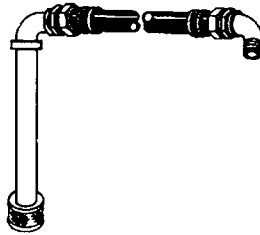

44-155, 44-355

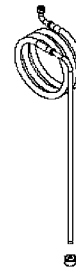

0115-010381

Siphon Hoses / Sets (55 Gallon)

| Part Number | Pumps Used with | Hose Size i.d. | Tube Size | Fitting Size | Siphon Hose Length | Included Screen (Mesh) | Container Size | Wetted Parts | Service Form |
|-------------|--------------------------------------|----------------|-------------------|------------------|--------------------|------------------------|----------------|------------------|------------------|
| 874501 | Infinity | 1" | 3/4" i.d. x 36" | 3/4" male, npt | 5 ft. | 30 | 55 Gallon | Stainless steel | n/a |
| 874580 | Infinity / Raptor | 1/2" | 1/2" i.d. x 35.5" | 1/2" male, npt | 5 ft. | 30 | 55 Gallon | Stainless steel | 77-5322 |
| 41-17233* | Comet 4/12 / Binks MX-4/12 & MX-4/32 | 3/8" | 3/8" i.d. x 36" | 3/4" female, nps | 8 ft. | 50 | 55 Gallon | Stainless steel | 77-5461, 77-2912 |
| 44-355 | Binks / Comet | 1" | 3/4" i.d. x 35" | 1" male, npt | 8 ft. | | 55 Gallon | Stainless steel | 77-2098 |
| 41-2616 | Binks / Comet | 3/4" | 3/4" i.d. x 33" | 3/4" male, npt | 8 ft. | 16 | 55 Gallon | Aluminum, steel | 77-2098 |
| 41-10467 | Binks / Comet | 1" | 1" i.d. x 35" | 1" male, npt | 8 ft. | 30 | 55 Gallon | Galvanized steel | 77-2098 |
| 0115-010381 | Binks MX-12/12 | 3/4" | | 3/4" female, nps | 10 ft. | | 55 Gallon | Stainless steel | 77-2917 |

*Requires adapter 0114-013801 for Comet 4/12.

*Requires adapter 0115-010235 for MX-4/12 and MX-4/32.

SEE PAGE 2-4 FOR REPLACEMENT INLET SCREENS

Fluid Filters, Screens/Strainers, Filter Elements & Filter/Surge Chambers

| | |
|--|------------|
| MATERIAL FILTERS, STRAINERS, SCREENS | 2-2 |
| HIGH PRESSURE IN LINE FILTERS | 2-3 |
| LOW PRESSURE IN LINE FILTERS | 2-3 |
| LOW PRESSURE IN LINE Y STRAINERS | 2-4 |
| INLET SCREENS (ROCK CATCHERS) | 2-4 |
| GUN MOUNTED MINI STRAINER | 2-4 |
| HIGH PRESSURE PUMP FILTER ELEMENTS | 2-5 |
| HIGH PRESSURE IN LINE FILTER ELEMENTS | 2-5 |
| LOW PRESSURE IN LINE FILTER ELEMENTS | 2-5 |
| SURGE CHAMBERS / PULSATION DAMPENERS | 2-6 |

Fluid Filters, Screens/Strainers, Filter Elements & Filter/Surge Chambers

2

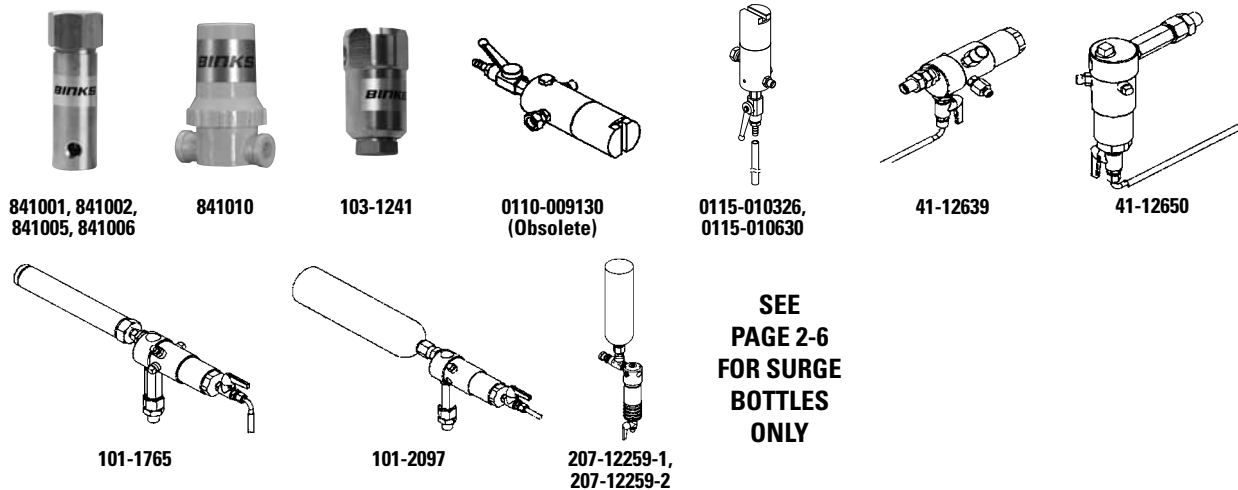

Material Filters, Strainers, Screens

| Part Number | Description | Inlet Port | Used with | Outlet Port | Mesh | Micron | Materials of Construction | Maximum Working Pressure | Service Form |
|--------------------------|---------------------------------------|-----------------|--------------------------------------|-----------------|------|--------|---------------------------|--------------------------|--------------|
| 841001 (OBS) | Material Filter | (2) 1/2" npt(f) | Infinity | (2) 1/2" npt(f) | 70 | 210 | Carbon steel | 6000 psi | 84100X |
| 841002 | Material Filter | (2) 1/2" npt(f) | Infinity | (2) 1/2" npt(f) | 100 | 149 | Carbon steel | 6000 psi | 84100X |
| 841005 | Material Filter | (2) 1/2" npt(f) | Infinity | (2) 1/2" npt(f) | 70 | 210 | Stainless steel | 6000 psi | 84100X |
| 841006 | Material Filter | (2) 1/2" npt(f) | Infinity | (2) 1/2" npt(f) | 100 | 149 | Stainless steel | 6000 psi | 84100X |
| 873188 | Outlet adapter to mount 841006 filter | 1" npt(m) | Infinity | 1/2" npt(m) | | | Stainless steel | 6000 psi | |
| 841010 | Material Filter | 3/8" npt(f) | Infinity Diaph | 3/8" npt(f) | 40 | 420 | Nylon, stn stl | 150 psi | 84101X |
| 103-1241* | Material Filter | 3/8" nps(f) | Binks / Comet | 1/4" npt(f) | 100 | 149 | Stainless steel | 4000 psi | 77-2015 |
| 0110-009130 (OBS) | Material Filter | 3/8" bspp(f) | Binks / Comet | 1/4" nps(m) | 100 | 149 | Stainless steel | 7200 psi | 77-2890 |
| 0115-010326 | Material Filter | 3/8" bspp(f) | Binks MX-4/12 & MX-4/32 / Comet 4/12 | 1/4" nps(m) | 100 | 149 | Stainless steel | 7200 psi | 77-2912 |
| 0115-010630 | Material Filter | 3/8" bspp(f) | Binks MX-4/12 & MX-4/32 / Comet 4/12 | 1/4" nps(m) | 200 | 149 | Stainless steel | 7200 psi | 77-2913 |
| 41-12639 | Material Filter | 1/2" npt(m) | Binks / Comet | 1/4" nps(m) | 50 | 297 | Carbon steel | 6000 psi | 77-2164 |
| 41-12650 | Material Filter | 1/2" npt(m) | Binks / Comet | 1/4" nps(m) | 50 | 297 | Carbon steel | 6000 psi | 77-2164 |
| 101-1765 | Material Filter/ Pulsation Chamber | 1/2" npt(m) | Binks / Comet | 1/4" nps(m) | 50 | 297 | Carbon steel | 6000 psi | 77-2469 |
| 101-2097 | Material Filter/ Pulsation Chamber | 1/2" npt(m) | Binks / Comet | 1/4" nps(m) | 50 | 297 | Carbon steel | 6000 psi | 77-2469 |
| 207-12259-1 | Material Filter/ Pulsation Chamber | 1/2" npt(f) | Binks / Comet | 1/2" npt(f) | 60 | 250 | Carbon steel/ aluminum | 1800 psi | 77-2807 |
| 207-12259-2 | Material Filter/ Pulsation Chamber | 1/2" npt(f) | Binks / Comet | 1/2" npt(f) | 100 | 149 | Carbon steel/ aluminum | 1800 psi | 77-2807 |

*Includes 1 ea, 101-9120 1/4" npt(m) x 1/4" npt(m) swivel adapter.

SEE PAGE 2-5 FOR REPLACEMENT SCREENS

Fluid Filters, Screens/Strainers, Filter Elements & Filter/Surge Chambers

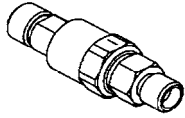

54-4725



54-3655

High Pressure In Line Filters

| Part Number | Description | Inlet Port | Used with | Outlet Port | Mesh | Micron | Materials of Construction | Maximum Working Pressure | Service Form |
|-------------|--------------------------|-------------|-----------|-----------------------|------|--------|---------------------------|--------------------------|--------------|
| 54-4725 | In-Line Edge Filter Assy | 1/4" nps(m) | Binks | 7/16-20 unf 2a thread | 100 | 149 | Stainless steel | 4000 psi | 77-2838 |
| 54-3655 | In-Line Edge Filter Assy | 1/4" nps(m) | Binks | 1/4" nps(f) | 100 | 149 | Stainless steel | 5800 psi | n/a |

SEE PAGE 2-5 FOR REPLACEMENT ELEMENTS



54-990, 54-981

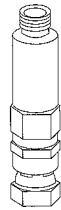

VS-534



VS-531

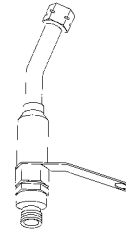

VS-532, 54-988, 54-982

Low Pressure In Line Filters

| Part Number | Description | Inlet Port | Used with | Outlet Port | Mesh | Micron | Materials of Construction | Maximum Working Pressure | Service Form |
|-------------|--------------------------|-------------|-----------|-------------|------|--------|---------------------------|--------------------------|--------------|
| 54-990 | In line Cartridge Filter | 3/8" nps(m) | Binks | 3/8" nps(f) | 100 | 149 | Plated brass | 150 psi | n/a |
| 54-981 | In line Cartridge Filter | 3/8" nps(m) | Binks | 3/8" nps(f) | 150 | 100 | Plated brass | 150 psi | n/a |
| VS-534 | In line Cartridge Filter | 3/8" nps(m) | Devilbiss | 3/8" nps(f) | 100 | 149 | Stainless steel | 300 psi | SB-7-072 |
| VS-531 | In line Cartridge Filter | 3/8" nps(m) | Devilbiss | 3/8" nps(f) | 100 | 149 | Carbon steel | 300 psi | SB-7-072 |
| VS-532 | In line Cartridge Filter | 3/8" nps(m) | Devilbiss | 3/8" nps(f) | 100 | 149 | Plated brass | 300 psi | SB-7-072 |
| 54-988 | In line Cartridge Filter | 3/8" nps(m) | Binks | 3/8" nps(f) | 100 | 149 | Plated brass | 150 psi | n/a |
| 54-982 | In line Cartridge Filter | 3/8" nps(m) | Binks | 3/8" nps(f) | 150 | 100 | Plated brass | 150 psi | n/a |

SEE PAGE 2-5 FOR REPLACEMENT ELEMENTS

Fluid Filters, Screens/Strainers, Filter Elements & Filter/Surge Chambers

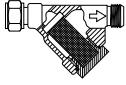

Low Pressure In Line Y-Strainers

| Part Number | Description | Inlet Port | Used with | Outlet Port | Mesh | Micron | Materials of Construction | Maximum Working Pressure | Service Form |
|-------------|----------------|-------------|-----------|-------------|------|--------|--------------------------------|--------------------------|--------------|
| 83-2922 | In Line Filter | 3/8" nps(f) | Binks | 3/8" nps(m) | 50 | 297 | Plated brass / Stainless steel | 200 psi | 77-2394 |
| 83-2923 | In Line Filter | 3/8" nps(f) | Binks | 3/8" nps(m) | 80 | 177 | Plated brass / Stainless steel | 200 psi | 77-2394 |
| 83-2924 | In Line Filter | 3/8" nps(f) | Binks | 3/8" nps(m) | 100 | 149 | Plated brass / Stainless steel | 200 psi | 77-2394 |
| 83-2925 | In Line Filter | 3/8" nps(f) | Binks | 3/8" nps(m) | 150 | 96 | Plated brass / Stainless steel | 200 psi | 77-2394 |
| 83-2926 | In Line Filter | 3/8" nps(f) | Binks | 3/8" nps(m) | 200 | 74 | Plated brass / Stainless steel | 200 psi | 77-2394 |

SEE PAGE 2-5 FOR REPLACEMENT ELEMENTS



101-142, 41-10094,
41-2661, 41-2662, 41-2663



41-17234-K10



41-2288

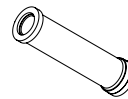

41-17241

Inlet Screens (Rock Catchers)

| Part Number | Thread Size | Materials of Construction | Mesh Size | Pumps used with |
|--------------|------------------------------|---------------------------------------|--------------|----------------------------------|
| 101-142 | 1" npt(f) | Stainless steel | 8/16 | Comets B,C,D |
| 41-10094 | 3/4" npt(f) | Stainless steel | 16 | Comets B,C,D |
| 41-2661 | 1/2" npt(f) | Stainless steel | 30 | Comets B,C,D / Raptor / MX-12/12 |
| 41-2662 | 3/4" npt(f) | Stainless steel | 30 | Comets B,C,D |
| 41-2663 | 1" npt(f) | Stainless steel | 30 | Comets B,C,D |
| 41-2288 | 1- 5/8" -12" npt(f) | Stainless steel | 30 (4" dia.) | Comets 3B and 4B Foot Valve |
| 41-17234-K10 | Ribbed hole 3/8" o.d. tubing | Rubber / stainless steel | 50 | Comet 4/12 |
| 41-17241-K2 | m12 x 1.25-6H screen | Stainless steel / Glass filled Teflon | 50 | Binks MX-4/12 and MX-4/32 |
| 237-755 | 3/16" or 1/4" i.d. tubing | Polypropylene | 75 micron | Unison Catalyst Supply Bottle |

SEE PAGES 1-7 AND 1-8 FOR SIPHON SUPPLY SETS

Gun Mounted Mini Strainer

| Part Number | Description | Inlet Port | Used with | Outlet Port | Mesh | Micron | Materials of Construction | Maximum Working Pressure |
|--------------|-------------|-------------|-------------------|-------------|------|--------|---------------------------|--------------------------|
| PLH-MF-6-100 | Gun Mounted | 3/8" nps(m) | Devilbiss / Binks | 3/8" nps(f) | 100 | 149 | Stainless steel | 250 psi |

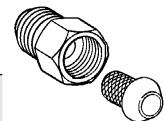

SEE PAGE 2-5 FOR REPLACEMENT ELEMENTS

Fluid Filters, Screens/Strainers, Filter Elements & Filter/Surge Chambers



873146, 873147



83-1256, 83-2089

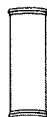

0110-009132



135-77, 135-78



54-980, 54-987



VS-58-K10



83-2405, 83-2596, 83-2705, 83-2706

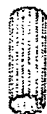

41-2627, 41-2628, 41-2629, 41-2630, 107-1527



207-11693, 207-11694



31144-310-K10



PLH-MFC-100



102-2181

High Pressure Pump Filter Elements

| Filter Assembly | Filter Element Standard | Mesh | Filter Element Optional | Mesh |
|---------------------|-------------------------|------|---|------------------|
| 841001 (OBS) | 873146 | 70 | 873147 | 100 |
| 841002 | 873147 | 100 | 873146 | 70 |
| 841005 | 873146 | 70 | 873147 | 100 |
| 841006 | 873147 | 100 | 873146 | 70 |
| 103-1241 | 83-1256 | 100 | 83-2089 | 50 |
| 0110-009130 (OBS) | 0110-009132 | 100 | 0110-009131 0110-009133 0110-009060 | 50 150 200 |
| 0115-010326 | 0110-009132 | 100 | 0110-009131 0110-009133 0110-009060 | 50 150 200 |
| 41-12650 & 41-12639 | 41-2629 | 50 | 41-2627 107-1527 | 100 20 |
| 207-12259-1 | 207-11693 | 60 | 207-11694 | 100 |
| 207-12259-2 | 207-11694 | 100 | 207-11693 | 60 |
| 101-1765 & 101-2097 | 41-2629 | 50 | 41-2627 107-1527 | 100 20 |

FOR USE WITH FILTER ASSEMBLIES ON PAGE 2-2



54-1835, 54-1836

High Pressure In Line Filter Elements

| Filter Assembly | Filter Element Standard | Mesh | Filter Element Optional | Mesh |
|-----------------|-------------------------|------|-------------------------|------|
| 54-4725 | 54-1835 | 100 | 54-1836 | 60 |
| 54-3655 | 54-1835 | 100 | 54-1836 | 60 |
| 54-3656 (OBS) | 54-1835 | 100 | 54-1836 | 60 |

FOR USE WITH FILTERS ON PAGE 2-3

Low Pressure In Line Filter Elements

| Filter Assembly | Filter Element Standard | Mesh | Filter Element Optional | Mesh |
|-----------------|-------------------------|---------|-------------------------|---------|
| 841010 | 135-78 | 40 x 36 | 135-77 | 80 x 80 |
| 83-29XX series | | | 83-2705 | 30 |
| 83-2922 | 83-2089 | 50 | | |
| 83-2923 | 83-2596 | 80 | | |
| 83-2924 | 83-1256 | 100 | | |
| 83-2925 | 83-2405 | 150 | | |
| 83-2926 | 83-2706 | 200 | | |
| 54-990 | 54-987 | 100 | | |
| 54-981 | 54-980 | 150 | | |
| 54-988 | 54-987 | 100 | | |
| 54-982 | 54-980 | 150 | | |
| VS-532 | VS-58-K10 | 100 | | |
| VS-534 | VS-58-K10 | 100 | | |
| VS-531 | 31144-310-K10 | 100 | | |
| PLH-MF-6-100 | PLH-MFC-100 | 100 | | |

FOR USE WITH FILTERS ON PAGES 2-3 AND 2-4



54-5788-K5, 54-5789-K5

High Pressure In Line Filter Elements

| Filter | Size (Mesh) | Where Used |
|------------|-------------|--------------------|
| 54-5788-K5 | 60 | AA-1600M, AA-4400M |
| 54-5789-K5 | 100 | AA-1600M, AA-4400M |

Fluid Filters, Screens/Strainers, Filter Elements & Filter/Surge Chambers

2



844000



873067



41-1020



237-847

Surge Chambers / Pulsation Dampeners



| Part Number | Pressure Range | Fitting Sizes | Wetted Parts | Notes | Service Form |
|-------------|----------------|--------------------|-------------------------------------|---|--------------|
| 844000 | 0-100 psi | 1" npt(f) fittings | Conductive acetal and teflon | Reduces pulsation by up to 97%. Helps reduce foaming and hydraulic shock. 873067 Grounding Kit. | 844000 |
| 873067 | n/a | n/a | n/a | Grounding Kit for 844000 | 840000 |
| 41-1020 | 0-4000 psi | 3/8" npt(f) | Plated steel, painted blue exterior | Surge bottle only | 77-2469 |
| 237-847 | 0-1800 psi | 3/4-16-unf-2b | Aluminum | Surge bottle only | 77-2807 |

Fluid Regulators, Gauges & Heaters

| | |
|---|-------------|
| FLUID REGULATORS | 3-2 |
| BACK PRESSURE FLUID REGULATORS | 3-6 |
| GUN MOUNT NON-CIRCULATING REGULATORS | 3-10 |
| GUN MOUNT CIRCULATING REGULATORS | 3-10 |
| FLUID REGULATOR KITS | 3-12 |
| PRESSURE GAUGES & RISER TUBES | 3-13 |
| FLUID HEATERS & FRP HEATER KITS | 3-14 |

Fluid Regulators, Gauges & Heaters

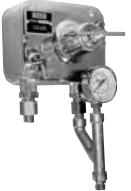
Low Pressure Fluid Regulators

| | Part Number | Wetted Parts | Inlet | Outlet | Inlet Pressure Min. | Inlet Pressure Max. | Outlet Pressure Min. | Outlet Pressure Max. | |
|---|-------------------|---------------------|------------|-------------------------|---------------------|---------------------|----------------------|----------------------|--|
|  | For Ceramic Glaze | | | | | | | | |
| | 84-120 | Nickel Plated Brass | 3/8"npt(m) | 3/8"nps(m) | n/a | 100 psi / 7 bar | 5 psi / .35 bar | 40 psi / 2.7 bar | |
|  | HGB-502-1 | Stainless steel | 3/8"npt(f) | (2) 3/8"npt(f) | 50 psi / 3.5 bar | 175 psi / 12 bar | 10 psi / .7 bar | 75 psi / 5 bar | |
| | HGB-508-1 | Stainless steel | 3/8"nps(f) | 3/8"nps(m) / 3/8"npt(f) | 50 psi / 3.5 bar | 175 psi / 12 bar | 10 psi / .7 bar | 75 psi / 5 bar | |
| | HGB-509-5-R38 | Stainless steel | 3/8bsp(f) | 3/8"nps / bsp(m) | 30 psi / 2 bar | 180 psi / 12.5 bar | | 75 psi / 5 bar | |
| | HGB-609-1.2-R38 | Stainless steel | 3/8"bsp(f) | 3/8"nps / bsp(m) | 15 psi / 1 bar | 115 psi / 8 bar | | 35 psi / 2.5 bar | |
| | HGB-609-5-R38 | Stainless steel | 3/8"bsp(f) | 3/8"nps / bsp(m) | 30 psi / 2 bar | 175 psi / 12 bar | | 75 psi / 5 bar | |
| | HGB-609-9-R38 | Stainless steel | 3/8"bsp(f) | 3/8"nps / bsp(m) | 45 psi / 3 bar | 215 psi / 15 bar | | 130 psi / 9 bar | |
|  | 84-410 | Stainless steel | 3/8"npt(f) | 3/8"nps(m) / 3/8"npt(f) | | 100 psi / 7 bar | 1 psi / .1 bar | 12 psi / 1 bar | |
| | 84-320 | Stainless steel | 3/8"npt(m) | 3/8"nps(m) | | 200 psi / 14 bar | 5 psi / .3 bar | 55 psi / 4 bar | |
| | 84-407 | Stainless steel | 3/8"npt(f) | 3/8"nps(m) | | 200 psi / 14 bar | 5 psi / .3 bar | 55 psi / 4 bar | |
| | 84-409 | Stainless steel | 3/8"npt(m) | 3/8"nps(m) / 3/8"npt(f) | | 200 psi / 14 bar | 5 psi / .3 bar | 100 psi / 7 bar | |
| | 84-346 | Zinc plated | 3/8"npt(m) | 3/8"nps(m) / 1/4"npt(f) | | 100 psi / 7 bar | 1 psi / .1 bar | 12 psi / 1 bar | |
| | 84-345 | Zinc plated | 3/8"npt(m) | 3/8"nps(m) | | 200 psi / 14 bar | 5 psi / .3 bar | 55 psi / 4 bar | |
| | 84-411 | Zinc plated | 3/8"npt(m) | 3/8"nps(m) | | 200 psi / 14 bar | 5 psi / .3 bar | 100 psi / 7 bar | |
| | 84-412 | Zinc plated | 3/8"npt(m) | 3/8"nps(m) | | 200 psi / 14 bar | 5 psi / .3 bar | 100 psi / 7 bar | |

Fluid Regulators, Gauges & Heaters



Low Pressure Fluid Regulators

| Part Number | Capacity | Type | Gauge | Shipping Weight | Service Forms |
|--------------------------|---------------------|------------------------------|---|-----------------|---------------|
| For Ceramic Glaze | | | | | |
| 84-120 | 1 gpm / 3.8 lpm | Key | 83-1355 gauge 100 / 0-7 bar | | 77-1417 |
| HGB-502-1 | 8 gpm / 30 lpm | Key (adaptable to remote) | None | | SB-6-375 |
| HGB-508-1 | 8 gpm / 30 lpm | Key (adaptable to remote) | HGB-14 riser tube & 83-2727 gauge 100 psi / 6.5 bar | | SB-6-375 |
| HGB-509-5-R38 | 3.4 gpm / 13 lpm | Key | None | | SB-6-HGB-H |
| HGB-609-1.2-R38 | 2.2 gpm / 8.3 lpm | Key | MA-25 gauge 35 psi / 2.5 bar | | SB-6-HGB-H |
| HGB-609-5-R38 | 3.4 gpm / 13 lpm | Key | 83-2727 gauge 100 psi / 7 bar | | SB-6-HGB-H |
| HGB-609-9-R38 | 3.4 gpm / 13 lpm | Key | GA-288 gauge 160 psi / 11 bar | | SB-6-HGB-H |
| 84-410 | 12 oz/Min. / .4 lpm | Key (adaptable to remote) | 84-348 riser tube & 83-1414 gauge 30 psi / 2 bar | | 77-1921 |
| 84-320 | 1 gpm / 3.8 lpm | Key (adaptable to remote) | 84-348 riser tube & 83-2571 gauge 100 psi / 6.5 bar | | 77-1486 |
| 84-407 | 1 gpm / 3.8 lpm | Remote operated | 84-348 riser tube & 83-2571 gauge 100 psi / 6.5 bar | | 77-1486 |
| 84-409 | 1 gpm / 3.8 lpm | Key (adaptable to remote) | 84-348 riser tube & 83-2571 gauge 100 psi / 6.5 bar | | 77-1915 |
| 84-346 | 12 oz/Min. / .4 lpm | Key (adaptable to remote) | 84-40 riser tube & 83-1636 gauge 15 psi / 1 bar | | 77-1758 |
| 84-345 | 1 gpm / 3.8 lpm | Key (adaptable to remote) | 84-40 riser tube & 83-1355 gauge 100 psi / 6.5 bar | | 77-1632 |
| 84-411 | 1 gpm / 3.8 lpm* | Key (adaptable to remote) | 84-40 riser tube & 83-1355 gauge 100 psi / 6.5 bar | | 77-2011 |
| 84-412 | 1 gpm / 3.8 lpm | Key (adaptable to remote) | 84-40 riser tube & 83-1290 gauge 150 psi / 10 bar | | 77-1632 |

* For high viscosity materials 2 gpm / 7.6 lpm for low viscosity

Fluid Regulators, Gauges & Heaters

Low Pressure Fluid Regulators

| Part Number | Wetted Parts | Inlet | Outlet | Inlet Pressure Min. | Inlet Pressure Max. | Outlet Pressure Min. | Outlet Pressure Max. |
|---|------------------------------------|----------------|----------------|---------------------|---------------------|----------------------|----------------------|
| Air pilot | | | | | | | |
|  HGB-510-R1 | Stainless steel | 1/4"bsp(f) | 1/4"bsp(f) | 30 psi / 2 bar | 220 psi / 15 bar | | 220 psi / 15 bar |
| HGB-510-R2 | Stainless steel | 1/4"bsp(f) | 1/4"bsp(f) | 15 psi / 1 bar | 220 psi / 15 bar | | 100 psi / 7 bar |
| HGB-510-R4 | Stainless steel | 1/4"bsp(f) | 1/4"bsp(f) | 15 psi / 1 bar | 220 psi / 15 bar | | 60 psi / 4 bar |
| HGB-510-R1-CO | Stainless steel | 3/8"nps/bsp(m) | 1/4"bsp(f) | 30 psi / 2 bar | 220 psi / 15 bar | | 220 psi / 15 bar |
| HGB-510-R2-CO | Stainless steel | 3/8"nps/bsp(m) | 1/4"bsp(f) | 15 psi / 1 bar | 220 psi / 15 bar | | 100 psi / 7 bar |
| HGB-510-R4-CO | Stainless steel | 3/8"nps/bsp(m) | 1/4"bsp(f) | 15 psi / 1 bar | 220 psi / 15 bar | | 60 psi / 4 bar |
|  845020 | Stainless steel / Tungsten carbide | 1/4"npt(f) | (2) 1/4"npt(f) | | 750 psi / 52 bar | 0 psi / 0 bar | 30 psi / 2 bar |
|  845004 | Stainless steel / Tungsten carbide | 3/8"npt(f) | 3/8"npt(f) | | 750 psi / 52 bar | 20 psi / 1.4 bar | 60 psi / 4 bar |

Medium Pressure Fluid Regulators

| Part Number | Wetted Parts | Inlet | Outlet | Inlet Pressure Min. | Inlet Pressure Max. | Outlet Pressure Min. | Outlet Pressure Max. |
|---|------------------------------------|------------|------------|---------------------|---------------------|----------------------|----------------------|
|  845001 | Stainless steel / Tungsten carbide | 3/8"npt(f) | 3/8"npt(f) | | 1250 psi / 86 bar | 100 psi / 7 bar | 800 psi / 55 bar |

Fluid Regulators, Gauges & Heaters

Low Pressure Fluid Regulators



| Part Number | Capacity | Type | Gauge | Shipping Weight | Service Forms |
|----------------------|-------------------|-------------------|---|-----------------|---------------|
| Air pilot | | | | | |
| HGB-510-R1 | .42 gpm / 1.6 lpm | Remote (4mm tube) | None | | SB-6-HGB-H |
| HGB-510-R2 | .35 gpm / 1.3 lpm | Remote (4mm tube) | None | | SB-6-HGB-H |
| HGB-510-R4 | .2 gpm / .8 lpm | Remote (4mm tube) | None | | SB-6-HGB-H |
| HGB-510-R1-CO | .42 gpm / 1.6 lpm | Remote (4mm tube) | None | | SB-6-HGB-H |
| HGB-510-R2-CO | .35 gpm / 1.3 lpm | Remote (4mm tube) | None | | SB-6-HGB-H |
| HGB-510-R4-CO | .2 gpm / .8 lpm | Remote (4mm tube) | None | | SB-6-HGB-H |
| 845020 | 3 gpm / 11.5 lpm | Hex key wrench | None | | 845020 |
| 845004 | 6 gpm / 23 lpm | Hex key wrench | Nipple, coupling & gauge 60 psi / 4 bar | 9 lbs. | 84500X |

Medium Pressure Fluid Regulators



| Part Number | Capacity | Type | Gauge | Shipping Weight | Service Forms |
|---------------|----------------|----------------|--|-----------------|---------------|
| 845001 | 6 gpm / 23 lpm | Hex key wrench | Nipple, coupling & gauge 1000 psi / 70 bar | 9 lbs. | 84500X |

Fluid Regulators, Gauges & Heaters

High Pressure Fluid Regulators

| | Part Number | Wetted Parts | Inlet | Outlet | Inlet Pressure Min. | Inlet Pressure Max. | Outlet Pressure Min. | Outlet Pressure Max. |
|--|-------------|------------------------------------|------------|------------|---------------------|---------------------|----------------------|----------------------|
|  | 845014 | Carbon Steel / Tungsten carbide | 3/8"npt(f) | 3/8"npt(f) | | 3000 psi / 207 bar | 400 psi / 28 bar | 1250 psi / 86 bar |
|  | 845011 | Stainless steel / Tungsten carbide | 3/8"npt(f) | 3/8"npt(f) | | 6000 psi / 414 bar | 1000 psi / 70 bar | 3000 psi / 207 bar |
| | 845013 | Stainless steel / Tungsten carbide | 3/8"npt(f) | 3/8"npt(f) | | 6000 psi / 414 bar | 2000 psi / 140 bar | 5000 psi / 345 bar |
| | 845010 | Stainless steel / Tungsten carbide | 3/8"npt(f) | 3/8"npt(f) | | 3000 psi / 207 bar | 400 psi / 28 bar | 1250 psi / 86 bar |
|  | 84-420 | Stainless steel | 1/4"npt(m) | 1/4"npt(f) | | 3000 psi / 210 bar | 300 psi / 21 bar | 2000 psi / 139 bar |
| | 84-520 | Stainless steel | 1/4"npt(m) | 1/4"npt(f) | | 2000 psi / 140 bar | 100 psi / 7 bar | 900 psi / 62 bar |

Back Pressure Regulators (Low Pressure)

| | Part Number | Wetted Parts | Inlet | Outlet | Inlet Pressure Min. | Inlet Pressure Max. | Outlet Pressure Min. | Outlet Pressure Max. |
|---|-------------|-----------------------------|--------------|--------------|---------------------|---------------------|----------------------|----------------------|
|  | 84-501 | Electroless nickel plated | 1/2"npt(f) | 1/2"npt(f) | | 150 psi / 10 bar | 10 psi / .7 bar | 140 psi / 10 bar |
| | 84-404 | Stainless steel | 3/4npt(f) | 3/4npt(f) | | 150 psi / 10 bar | 10 psi / .7 bar | 140 psi / 10 bar |
| | 84-504 | Stainless steel | 1-1/4"npt(f) | 1-1/4"npt(f) | | 150 psi / 10 bar | 10 psi / .7 bar | 140 psi / 10 bar |
| | 84-601 | Stainless steel (low shear) | 1/2"npt(f) | 1/2"npt(f) | | 200 psi / 14 bar | 0 psi / 0 bar | 130 psi / 9 bar |
|  | 845000 | Stainless steel | 3/8"npt(f) | 3/8"npt(f) | | 200 psi / 14 bar | 0 psi / 0 bar | 200 psi / 14 bar |
| | 845003 | Stainless steel | 1-1/4"npt(f) | 1-1/4"npt(f) | | 200 psi / 14 bar | 0 psi / 0 bar | 200 psi / 14 bar |
|  | HGBR-609 | Stainless steel | 1/4"npt(f) | 1/4"npt(f) | 30 psi / 2 bar | 180 psi / 12.5 bar | 0 psi / 0 bar | 130 psi / 9 bar |

Fluid Regulators, Gauges & Heaters

High Pressure Fluid Regulators

| Part Number | Capacity | Type | Gauge | Shipping Weight | Service Forms |
|-------------|------------------|----------------|--|-----------------|---------------|
| 845014 | 3 gpm / 11.5 lpm | Hex key wrench | None | 9 lbs. | 845010 |
| 845011 | 3 gpm / 11.5 lpm | Hex key wrench | None | 9 lbs. | 84501X |
| 845013 | 6 gpm / 23 lpm | Hex key wrench | None | | 84501X |
| 845010 | 3 gpm / 11.5 lpm | Hex key wrench | None | | 84501X |
| 84-420 | 1 gpm / 3.8 lpm | T- handle | Optional gauge 101-3069 3000 psi / 207 bar | | 77-1908 |
| 84-520 | 1 gpm / 3.8 lpm | T- handle | Optional gauge 84-491 1000 psi / 70 bar | | 77-1908 |

Back Pressure Regulators (Low Pressure)



| Part Number | Capacity | Type | Gauge | Shipping Weight | Service Forms |
|-------------|-------------------|---------|--|-----------------|---------------|
| 84-501 | 7 gpm / 26 lpm | Key | Optional 84-40 connection & 83-1290 gauge 150 psi / 10 bar | | 77-1662 |
| 84-404 | 11 gpm / 42 lpm | Key | Optional 84-348 riser tube & 83-2744 gauge 200 psi / 13 bar | | 77-1889 |
| 84-504 | 11 gpm / 42 lpm | Key | Optional 84-348 riser tube & 83-2744 gauge 200 psi / 13 bar | | 77-1889 |
| 84-601 | 1 gpm / 3.8 lpm | Key | 84-348 riser tube & 83-2744 gauge 200 psi / 13 bar | | 77-2629 |
| 845000 | 6 gpm / 23 lpm | Hex key | Nipple, coupling & gauge 300 psi / 21 bar | 9 lbs. | 84500X |
| 845003 | 18.5 gpm / 70 lpm | Hex key | Nipple, coupling & gauge 300 psi / 21 bar | 9 lbs. | 84500X |
| HGBR-609 | 4.9 gpm / 18 lpm | Key | Riser tube & gauge GA-288 160 psi / 11 bar | | SB-6-HGBR-A |

Fluid Regulators, Gauges & Heaters

Back Pressure Regulators (Medium Pressure)

| | Part Number | Wetted Parts | Inlet | Outlet | Inlet Pressure Min. | Inlet Pressure Max. | Outlet Pressure Min. | Outlet Pressure Max. |
|---|-------------|-----------------|------------|------------|---------------------|---------------------|----------------------|----------------------|
|  | 845002 | Stainless steel | 3/8"npt(f) | 3/8"npt(f) | | 800 psi / 55 bar | 0 psi / 0 bar | 800 psi / 55 bar |

Back Pressure Regulators (High Pressure)

| | Part Number | Wetted Parts | Inlet | Outlet | Inlet Pressure Min. | Inlet Pressure Max. | Outlet Pressure Min. | Outlet Pressure Max. |
|---|-------------|-----------------|------------|------------|---------------------|---------------------|----------------------|----------------------|
|  | 84-421 | Stainless steel | 1/4"npt(f) | 1/4"npt(m) | | 3000 psi / 207 bar | 100 psi / 7 bar | 2000 psi / 140 bar |
|  | 845012 | Stainless steel | 3/8"npt(f) | 3/8"npt(f) | | 3000 psi / 207 bar | 100 psi / 7 bar | 3000 psi / 207 bar |

Fluid Regulators, Gauges & Heaters

Back Pressure Regulators (Medium Pressure)

| Part Number | Capacity | Type | Gauge | Service Forms |
|-------------|----------------|---------|--|---------------|
| 845002 | 6 gpm / 23 lpm | Hex key | Nipple, coupling & gauge 1000 psi / 70 bar | 84500X |

Back Pressure Regulators (High Pressure)

| Part Number | Capacity | Type | Gauge | Service Forms |
|-------------|-----------------|-----------|--|---------------|
| 84-421 | 1 gpm / 3.8 lpm | T- handle | Optional 101-3069 gauge 3000 psi / 207 bar | 77-1909 |
| 845012 | 6 gpm / 23 lpm | Hex key | None | 84501X |

Fluid Regulators, Gauges & Heaters

Gun Mount Non-Circulating Regulators

| Part Number | Description / Wetted Parts | Inlet | Outlet | Inlet Press. Min. | Inlet Press. Max. | Outlet Press. Min. | Outlet Press. Max. |
|-------------|------------------------------|-------------|-----------------------|-------------------|-------------------|--------------------|--------------------|
| 84-585 | Stainless steel low pressure | 1/4" nps(m) | 3/8" nps(f) sw | n/a | 250 psi | 0 psi | 50 psi |
| HGS-5132 | Stainless steel low pressure | 1/8" npt(f) | 3/8" nps(f) sw | 50 psi | 300 psi | 2 psi | 100 psi |
| HGS-5133 | Stainless steel low pressure | 1/8" npt(f) | 1/4" nps(m) standpipe | 50 psi | 300 psi | 2 psi | 100 psi |
| HGS-5231 | Stainless steel low pressure | 1/8" npt(f) | Bayonet lock (q.d.) | 50 psi | 300 psi | 2 psi | 100 psi |
| HGS-5232 | Stainless steel low pressure | 1/8" npt(f) | 3/8" nps(f) swivel | 50 psi | 300 psi | 2 psi | 100 psi |
| HGS-5233 | Stainless steel low pressure | 1/8" npt(f) | 1/4" nps(m) standpipe | 50 psi | 300 psi | 2 psi | 100 psi |
| HGS-5239 | Stainless steel low pressure | 3/8" nps(f) | 3/8" nps(m) | 50 psi | 300 psi | 2 psi | 100 psi |
| HGS-5242 | Stainless steel | 3/8" nps(m) | 3/8" nps(f) sw | 50 psi | 300 psi | 2 psi | 100 psi |

Gun Mount Circulating Regulators

| Part Number | Description / Wetted Parts | Inlet | Outlet | Inlet Press. Min. | Inlet Press. Max. | Outlet Press. Min. | Outlet Press. Max. |
|-------------|--|-----------------|--------------------------------|-------------------|-------------------|--------------------|--------------------|
| 84-525 | Stainless steel | 1/4" nps(m) | 3/8" nps(f) sw/ 1/4" nps(m) | n/a | 250 psi | 0 psi | 50 psi |
| HGS-5112 | Stainless steel | 1/4" nps(m) | 3/8" nps(f) sw | 50 psi | 300 psi | 2 psi | 100 psi |
| HGS-5113 | Stainless steel | 1/4" nps(m) | 1/4" nps(m) standpipe | 50 psi | 300 psi | 2 psi | 100 psi |
| HGS-5122 | Stainless steel | 3/8" nps(m) | 3/8" nps(f) sw | 50 psi | 300 psi | 2 psi | 100 psi |
| HGS-5211 | Stainless steel | 1/4" nps(m) | Bayonet lock (q.d.) | 50 psi | 300 psi | 2 psi | 100 psi |
| HGS-5212 | Stainless steel | 1/4" nps(m) | 3/8" nps(f) sw | 50 psi | 300 psi | 2 psi | 100 psi |
| HGS-5221 | Stainless steel | 3/8" nps(m) | Bayonet lock (q.d.) | 50 psi | 300 psi | 2 psi | 100 psi |
| HGS-5222 | Stainless steel | 3/8" nps(m) x 2 | 3/8" nps(f) sw | 50 psi | 300 psi | 2 psi | 100 psi |
| HGS-5313 | Stainless steel | 1/4" nps(m) | 1/4" nps(m) standpipe | 50 psi | 300 psi | 2 psi | 100 psi |
| 84-261 | s.s. Circulating Conn w/ Restrictor | 3/8" nps(m) | 3/8" nps(f) sw | 0 psi 0 bar | 200 psi | n/a | n/a |
| 72-1823 | s.s. Circulating Conn. | 3/8" nps(m) x 2 | 3/8" nps(f) | 0 psi 0 bar | 200 psi | n/a | n/a |

Fluid Regulators, Gauges & Heaters

Gun Mount Non-Circulating Regulators

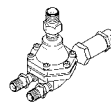

Style 5A

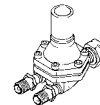

Style 5B

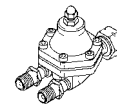

Style 5C



Style 13B



| Part Number | Capacity | Type | Gauge | Style* | Service Forms |
|-------------|--------------|--------------------|-------|----------|---------------|
| 84-585 | n/a | Manually adjusted | None | 13B | 77-2689 |
| HGS-5132 | 2500 ml /min | Air pilot (remote) | None | 5A,B & C | SB-6-403 |
| HGS-5133 | 2500 ml /min | Air pilot (remote) | None | 5A,B & C | SB-6-403 |
| HGS-5231 | 2500 ml /min | Manual | None | 5A,B & C | SB-6-403 |
| HGS-5232 | 2500 ml /min | Manual | None | 5A,B & C | SB-6-403 |
| HGS-5233 | 2500 ml /min | Manual | None | 5A,B & C | SB-6-403 |
| HGS-5239 | 2500 ml /min | Manual | None | 5A,B & C | SB-6-403 |
| HGS-5242 | 2500 ml /min | Manual | None | 5A,B & C | SB-6-403 |

Gun Mount Circulating Regulators

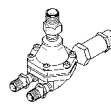

Style 5A

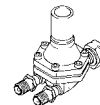

Style 5B

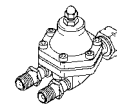

Style 5C



Style 13B



| Part Number | Capacity | Type | Gauge | Style* | Service Forms |
|-------------|--------------|-------------------------|-------|----------|---------------|
| 84-525 | 1/2 GPM | Spray gun mount | None | 13B | 77-2594 |
| HGS-5112 | 2500 ml /min | Air pilot (remote) | None | 5A,B & C | SB-6-403 |
| HGS-5113 | 2500 ml /min | Air pilot (remote) | None | 5A,B & C | SB-6-403 |
| HGS-5122 | 2500 ml /min | Air pilot (remote) | None | 5A,B & C | SB-6-403 |
| HGS-5211 | 2500 ml /min | Manual | None | 5A,B & C | SB-6-403 |
| HGS-5212 | 2500 ml /min | Manual | None | 5A,B & C | SB-6-403 |
| HGS-5221 | 2500 ml /min | Manual | None | 5A,B & C | SB-6-403 |
| HGS-5222 | 2500 ml /min | Manual | None | 5A,B & C | SB-6-403 |
| HGS-5313 | 2500 ml /min | Manual tamper resistant | None | 5A,B & C | SB-6-403 |
| 84-261 | n/a | n/a | None | n/a | 77-2096 |
| 72-1823 | n/a | n/a | None | n/a | n/a |

Fluid Regulators, Gauges & Heaters

Fluid Regulator Repair Kits

| Regulator Part No. | Repair Kit | Diaphragm Kit | Valve & Seat Kit | Service Form |
|--------------------|------------|---------------|------------------|--------------|
| 84-120 | n/a | n/a | n/a | 77-1417 |
| 84-320 | 6-1310 | n/a | n/a | 77-1486 |
| 84-345 | 6-221 | n/a | n/a | 77-1632 |
| 84-346 | 84-591 | 84-592 | n/a | 77-1758 |
| 84-404 | n/a | 6-1310 | 6-1312 | 77-1889 |
| 84-407 | 6-1310 | n/a | n/a | 77-1486 |
| 84-409 | 6-210 | n/a | n/a | 77-1915 |
| 84-410 | 84-591 | 84-592 | n/a | 77-1921 |
| 84-411 | 6-210 | n/a | n/a | 77-2011 |
| 84-412 | 6-221 | n/a | n/a | 77-1632 |
| 84-415 (OBS) | 84-591 | 84-592 | n/a | 77-1758 |
| 84-420 | 6-1306 | n/a | n/a | 77-1908 |
| 84-421 | 6-1306 | n/a | n/a | 77-1909 |
| 84-501 | n/a | 6-1310 | 6-1311 | 77-1662 |
| 84-504 | n/a | 6-1310 | 6-1312 | 77-1889 |
| 84-520 | 6-1306 | n/a | n/a | 77-1908 |
| 84-525 | n/a | 6-1305 | n/a | 77-2594 |
| 84-585 | n/a | 6-1305 | n/a | 77-2689 |
| 84-598 | 6-525 | 6-525 | 6-525 | 77-2871 |
| 84-599 | 6-526 | 6-526 | 6-526 | 77-2871 |
| 84-601 | n/a | 6-1309 | n/a | 77-2629 |
| 845000 | 863011 | n/a | n/a | 84500X |
| 845001 | 863010 | 863003 | 863005 | 84500X |
| 845002 | 863011 | n/a | n/a | 84500X |
| 845003 | 863012 | 863003 | 863004 | 84500X |
| 845004 | 863018 | 863003 | 863007 | 84500X |
| 845010 | 863013 | 863008 | 863007 | 84501X |
| 845011 | 863013 | 863008 | 863007 | 84501X |

Fluid Regulator Repair Kits

| Regulator Part No. | Repair Kit | Diaphragm Kit | Valve & Seat Kit | Service Form |
|--------------------|------------|---------------|------------------|--------------|
| 845012 | 863011 | 863003 | 863001 | 84500X |
| 845013 | 863015 | 863008 | 863005 | 84501X |
| 845014 | 863013 | 863008 | 863007 | 84501X |
| 845020 | n/a | n/a | n/a | 845020 |
| HGB-502-1 | n/a | KK-4216 | HGB-406-4-K | SB-6-375 |
| HGB-508-1 | n/a | KK-4216 | HGB-406-4-K | SB-6-375 |
| HGB-509-5-R38 | n/a | HGB-422 | HGB-426-00 | SB-6-HGB-H |
| HGB-510-R2 | n/a | HGB-424 | HGB-426 | SB-6-HGB-H |
| HGS-5112 | KK-4456 | n/a | n/a | SB-6-403 |
| HGS-5113 | KK-4456 | n/a | n/a | SB-6-403 |
| HGS-5122 | KK-4456 | n/a | n/a | SB-6-403 |
| HGS-5132 | KK-4456 | n/a | n/a | SB-6-403 |
| HGS-5133 | KK-4456 | n/a | n/a | SB-6-403 |
| HGS-5211 | KK-4456 | n/a | n/a | SB-6-403 |
| HGS-5212 | KK-4456 | n/a | n/a | SB-6-403 |
| HGS-5221 | KK-4456 | n/a | n/a | SB-6-403 |
| HGS-5222 | KK-4456 | n/a | n/a | SB-6-403 |
| HGS-5231 | KK-4456 | n/a | n/a | SB-6-403 |
| HGS-5232 | KK-4456 | n/a | n/a | SB-6-403 |
| HGS-5233 | KK-4456 | n/a | n/a | SB-6-403 |
| HGS-5239 | KK-4456 | n/a | n/a | SB-6-403 |
| HGS-5242 | KK-4456 | n/a | n/a | SB-6-403 |
| HGS-5313 | KK-4456 | n/a | n/a | SB-6-403 |

Fluid Regulators, Gauges & Heaters



GA-288



237-765

Fluid Pressure Gauges

| Part No. | Capacity Pressure | Thread Size & Position | | Notes |
|----------|-------------------|------------------------|-------------|--|
| | | Bottom | Back | |
| GA-73 | 30 psi | 1/4" npt(m) | | 2" diameter |
| MA-25 | 35 psi / 2.5 bar | 1/4" bspt | | 50 mm dia. – used on HGB-609-1.2R38 fluid regulators |
| 237-765 | 100 psi | | 1/8" npt(m) | 1-1/2" diameter stainless steel |
| 83-2571 | 100 psi | 1/4" npt(m) | | 2-11/16" diameter with stainless steel bourdon tube |
| GA-288 | 160 psi | 1/4" npt(m) | | 2" diameter |
| 84-246 | 200 psi | 1/4" npt(m) | | 2-1/2" diameter with pulse diaphragm |
| 84-491 | 1000 psi | 1/4" npt(m) | | 2-1/2" diameter w / diaphragm |
| 101-3069 | 3000 psi | 1/4" npt(m) | | 2-7/64" diameter w / pulse diaphragm |
| 873055 | 3000 psi | | 1/4" npt(m) | Stainless steel |

Liquid Filled Stainless Steel

| Part No. | Capacity Pressure | Thread Size & Position | | Notes |
|----------|-------------------|------------------------|------|--|
| | | Bottom | Back | |
| 107-1433 | 2000 psi | 1/4" npt(m) | | Used on 101-1950 stainless steel pump assembly |
| 107-1637 | 1000 psi | 1/4" npt(m) | | |

Riser Tubes (For Fluid Regulators / Gauges)

| Part Number | Size | Size | Length | Materials | Max. Working Pressure | Where Used | Service Form |
|-------------|-------------|-------------|--------|---------------|-----------------------|---|---------------------------------------|
| HGB-14 | 3/8" npt(m) | 1/4" npt(f) | 3 1/2" | 303 Stn. Stl. | 250 PSI | HGB and HGBR Series Regs and BPR's | SB-6-375 SB-6-HGB-H SB-6-HGBR-A |
| 84-348 | 1/4" npt(m) | 1/4" npt(f) | 3" | 303 Stn. Stl. | 250 PSI | Reg's: 84-410, 84-320, 84-407, 84-409 | 77-1921, 77-1486 77-1486, 77-1915 |
| 84-40 | 1/4" npt(m) | 1/4" npt(f) | 3" | Brass | 250 PSI | Reg's: 84-345, 84-346 84-411, 84-412 | 77-1632, 77-1758 77-2011, 77-1632 |



Fluid Regulators, Gauges & Heaters



High pressure, lightweight (28 lbs), compact construction. Working capacity to 5000 psi and with adjustable thermostatic control from 60° to 250°F. The typical temperature rise with a flow of 32 fl. oz./min. while maintaining a temperature of 100% above ambient is 100°F. 1/2" npt(f) inlet and outlet ports. (CSA listed, CE approved)

Capacity of fluid in heater: 0.162 L
Fluid Passage Length: 91.7"
Ports: 1/2" npt(f)

Fluid Heaters

| Part Number | Max. Working Pressure | Temp Range | Wetted Parts | Voltage | Amperage | Mntg Hdwe | Wattage | Service Form |
|-------------|-----------------------|----------------|-----------------|---------|-----------|-----------|------------|--------------|
| 830000 | 5000 psi | 60 - 250 Deg F | Stainless steel | 120 vac | 16.6 amps | Included | 2000 Watts | 83000X |
| 830001 | 5000 psi | 60 - 250 Deg F | Stainless steel | 240 vac | 8.33 amps | Included | 2000 Watts | 83000X |
| 830002 | 5000 psi | 60 - 250 Deg F | Stainless steel | 440 vac | 4.5 amps | Included | 2000 Watts | 83000X |

FRP Heater Kits

| Part Number | Description |
|-------------|---|
| 207-12351 | 115 volt mounting hardware kit, 2 fittings & hose – for mounting heaters to Unison (FRP) pump systems |
| 207-12352 | 220 volt mounting hardware kit, 2 fittings & hose – for mounting heaters to Unison (FRP) pump systems |

Air & Fluid Valves

| | |
|---|------------|
| BALL VALVES (LOW PRESSURE) | 4-2 |
| BALL VALVES (HIGH PRESSURE) | 4-2 |
| BALL VALVES (AIR VENT) | 4-3 |
| VA SERIES VALVES (AIR & FLUID) | 4-3 |
| AIR ADJUSTMENT VALVES | 4-4 |
| PRESSURE SAFETY RELIEF VALVES | 4-4 |

Air & Fluid Valves

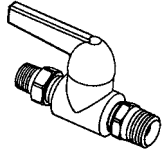

Ball Valves (Low Pressure)

| Part No. | Thread Sizes | Max. Working Pressure | Materials | Useage | Service Form |
|----------|-------------------|-----------------------|------------------------|-------------------|--------------|
| 72-83030 | 1/4"m x 1/4"m • | 250 psi | Die cast (zinc plated) | Air / Fluid | 77-2806 |
| 72-84040 | 3/8"m x 3/8"m • | 250 psi | Die cast (zinc plated) | Air / Fluid | 77-2806 |
| 72-81414 | 1/4"f x 1/4"f | 250 psi | Die cast (zinc plated) | Air / Fluid | 77-2806 |
| 72-84030 | 3/8"m x 1/4"m • | 250 psi | Die cast (zinc plated) | Air / Fluid | 77-2806 |
| 72-81540 | 3/8"f x 3/8"m | 250 psi | Die cast (zinc plated) | Air / Fluid | 77-2806 |
| 73-81414 | 1/4"f x 1/4"f + | 250 psi | Plated brass | 3 Way Air / Fluid | 77-2806 |
| 73-83030 | 1/4"m x 1/4"m • + | 250 psi | Plated brass | 3 Way Air / Fluid | 77-2806 |
| 73-84040 | 3/8"m x 3/8"m • + | 250 psi | Plated brass | 3 Way Air / Fluid | 77-2806 |
| 849311 | 1/2"npt(f) | 175 psi | Cast aluminum | Air | n/a |

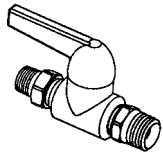

Ball Valves (High Pressure)

| Part No. | Thread Sizes | Max. Working Pressure | Materials | Useage | Service Form |
|-----------|-----------------|-----------------------|-----------------|--------|--------------|
| 72-13030 | 1/4"m x 1/4"m • | 4000 psi | Brass/steel | Fluid | 77-2806 |
| 72-14040 | 3/8"m x 3/8"m • | 4000 psi | Brass/steel | Fluid | 77-2806 |
| 72-14030 | 3/8"m x 1/4"m • | 4000 psi | Brass/steel | Fluid | 77-2806 |
| 172-33535 | 1/4"m x 1/4"m • | 4000 psi | Stainless steel | Fluid | 77-2806 |
| 172-34545 | 3/8"m x 3/8"m • | 4000 psi | Stainless steel | Fluid | 77-2806 |
| 172-31414 | 1/4"f x 1/4"f | 4000 psi | Stainless steel | Fluid | 77-2806 |

• m = male thread (universal thread for use with "npt or" nps connections.)
 + = 1/4" npt(f) inlet fittings
 f = female thread (npt)
 fbe = female both ends

Air & Fluid Valves

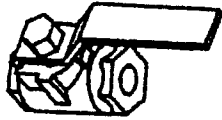

237-269, 73-91100, 73-91300
Vented Ball Valve (Air)

Ball Valves (Air Vent)

| Part No. | Thread Sizes | Max. Working Pressure | Materials | Useage | Service Form |
|----------|----------------|-----------------------|-----------|------------|--------------|
| 237-269 | 1/2" npt (fbe) | 250 psi | Brass | Air | n/a |
| 73-91100 | 3/8" npt (fbe) | 250 psi | Brass | Air / Vent | n/a |
| 73-91300 | 3/4" npt (fbe) | 250 psi | Brass | Air / Vent | n/a |



VA Series
Ball Valves

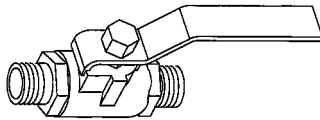

VA-595
Vented Ball Valve (Air)

VA Series Valves (Air & Fluid)

| Part No. | Thread Sizes | Max. Working Pressure | Materials | Useage | Service Form |
|----------|---------------------------|-----------------------|-----------------|--------------|--------------|
| VA-527 | 3/8" npt(m) x 3/8" nps(m) | 500 psi | Stainless steel | Air / Fluid | SB-11-119 |
| VA-528 | 3/8" m x 3/8" f | 500 psi | Stainless steel | Air / Fluid | SB-11-119 |
| VA-540 | 3/8" m x 3/8" m | 500 psi | Brass | Air / Fluid | SB-11-119 |
| VA-542 | 1/4" m x 1/4" m | 500 psi | Brass | Air / Fluid | SB-11-119 |
| VA-595 | 1/2" npt(mbe) | 175 psi | Brass | Air / Vented | SB-11-119 |

m = male thread
f = female thread (npt)
fbe = female both ends
mbe = male both ends

Air & Fluid Valves

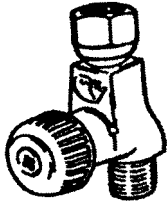

HAV-500
Air Valve



HAV-501
Air Valve



P-H-5516
In Line Air Valve

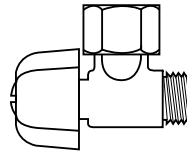

73-159

Air Adjusting Valves/Needle Valves/Cheater Valves

| Part Number | Type | Inlet Size | Outlet Size | W or W/O Gauge Assy. | Max. Working Pressure | Recommended Range | Service Form |
|-----------------|-----------|---------------|---------------|----------------------|-----------------------|-------------------|--------------|
| 873409 | Straight | 1/4" npt(fbe) | 1/4" npt(fbe) | W/O | 100 psi | 0-100 psi | n/a |
| HAV-500 | Straight | 1/4" nps(m) | 1/4" nps(f) | W/O | 125 psi | 0-125 psi | SB-11-119 |
| HAV-501 | Straight | 1/4" nps(m) | 1/4" nps(f) | W / gauge | 125 psi | 0-125 psi | SB-11-119 |
| 73-159 | 90 Degree | 1/4" nps(m) | 1/4" nps(f) | W/O | 250 psi | 0-125 psi | n/a |
| P-H-5516 | 45 Degree | 1/4" nps(m) | 1/4" nps(f) | W/O | 250 psi | 0-125 psi | SB-11-119 |

fbe = Female Both Ends



Safety Valves

Pressure Safety Relief Valves

| Part No. | Pressure Rating | npt Male Thread | Service Form | Notes |
|-----------------|-----------------|-----------------|--------------|--|
| TIA-4326 | 18 psi | 1/8" | SB-11-661 | Used on 85-435 regulator and KK-4980 regulator kit |
| TIA-5040 | 40 psi | 1/4" | n/a | Used on 183- tanks with extra-sensitive regulators |
| TIA-4355 | 55 psi | 1/4" | SB-11-661 | Used on KB Series cups |
| TIA-5080 | 80 psi | 1/4" | SB-11-661 | Replacement for TIA-4380—used on 2.8 gallon pressure tanks |
| TIA-5110 | 110 psi | 1/4" | SB-11-661 | Used on 110 psi ASME code tanks |
| 85-243 | 55 psi | 1/8" | n/a | Used on 80-295 2-qt. cups |

Hose, Connections & Assemblies

| | |
|--|-------------|
| REUSABLE CONNECTIONS | 5-2 |
| UNDERSTANDING PRESSURE DROP | 5-3 |
| TECHNICAL DATA | 5-4 |
| BULK AIR HOSE & CONNECTIONS | 5-5 |
| BULK FLUID HOSE & CONNECTIONS | 5-8 |
| TUBING & CONNECTIONS | 5-9 |
| AIR HOSE ASSEMBLIES | 5-12 |
| FLUID HOSE ASSEMBLIES | 5-14 |
| FRP HOSE ASSEMBLIES | 5-19 |
| CATALYST HOSE ASSEMBLIES (FRP) | 5-21 |

Hose, Connections & Assemblies

Reusable Connections



Type A. Plated Brass

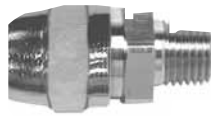

Type B. Plated Brass



Type C. Plated Brass

How to Install Compression Sleeve Type Connections

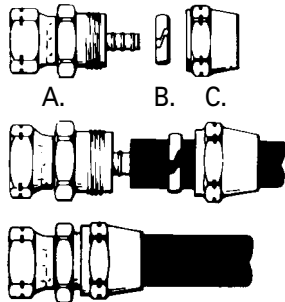

Place a matching double male nipple in a vise and tighten. Screw swivel nut onto fitting and tighten. Remove nut and sleeve from connector. Cut hose end square and slide nut over hose approximately 2 inches back from cut. Spread sleeve ring just enough to slide over hose easily. Push hose onto connector body, twisting hose slightly as you push to insure proper seating. Slide sleeve forward and tighten nut until connector body begins to turn. Remove double male nipple—hose and connection are ready to use. Tools required: vise, double male nipple, adjustable wrench, knife.

This connection consists of three (3) pieces:

- A. Swivel nut and connector body
- B. Sleeve
- C. Nut

How to Install Punch-Lok Type Connections

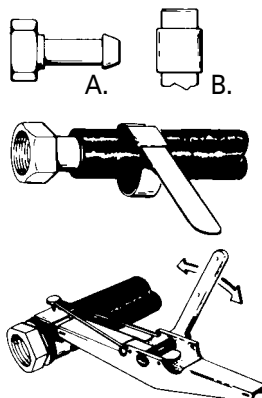

Place a matching double male nipple in a vise and tighten. Screw swivel nut onto fitting and tighten. Cut hose end square and slide Punch-Lok strap onto hose about 3 inches from cut end. Push hose onto connection tailpiece and slide strap forward to approximately 1/4 inch from connector body nut. Insert end of strap into Punch-Lok tool and tighten. Do not overtighten or strap will cut hose. Hold tension on strap and position punch. Strike punch with hammer to lock strap in place. The Punch-Lok tool, when moved up and down will sever excess strap. Remove double male nipple, and hose connection is complete. Tools required: Vise, Punch-Lok tool, double male nipple, adjustable wrench, knife, hammer.

This connection consists of two (2) pieces:

- A. Swivel nut with tailpiece
- B. Punch-Lok strap

E.V.A. = Ethylene Vinyl Acetate E.P.D.M. = Ethylene Propylene Diene Rubber s.s. = Stainless steel
 Steel pltd = Steel plated Brass pltd = Brass plated n/a = Not available

Hose, Connections & Assemblies

Understanding Pressure Drop

Pressure Drop Basics

Understanding pressure drop requires a basic knowledge of cfm (cubic feet per minute) and psi (pounds per square inch). cfm refers to the given volume of air that flows past a given point in one minute. psi is the amount of force pushing the cubic foot of air through the hose or tool.

The amount of air that a tool consumes will remain constant for a given set of conditions. Pressure will always drop when the tool is turned on and when the air begins to flow through the hose. In addition, pressure drop will vary in relation to any adjustment made on the tool.

The same pressure loss principles apply when moving fluid through a hose. Be sure to consider pressure loss when choosing fluid hose and fittings.

Pressure Drop Points

Losses in pressure (psi) are dependent on the variables of hose length, hose diameter, volume (cfm), and the number and design of quick disconnects. To minimize the effects of pressure drop and the resulting lack of volume, consider the following:

- Frictional resistance between the fluid and the walls of the hose
- Internal resistance (shear)—fluid moves faster through the center of the hose and slower against the walls
- Change in direction of air or fluid through the system
- Volume at any given time as determined by back pressure
- The number of system connections, adapters, nipples, valves, filters, and air and fluid controls
- Hose i.d.—use the minimum i.d. necessary for each application
- Hose length—pressure drop is proportional to hose length
- Surface of the hose's inner tube—a rough surface can increase pressure drop up to 50%

Pressure Drop Chart Hose Sizes: 1/4" to 1" I.D.

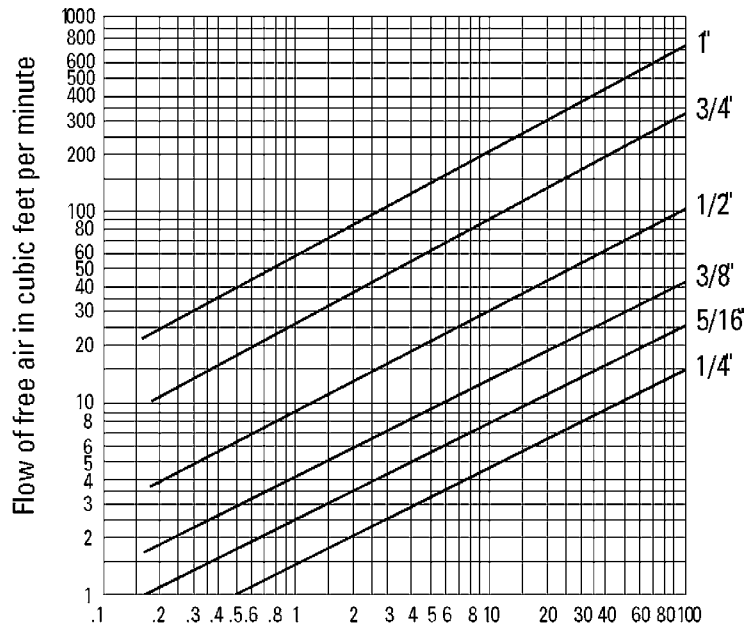

Pressure drop in pounds per sq. in., per 100 ft. of hose

To determine pressure drops for hose lengths other than 100 ft.:

$$(\text{Pressure Drop Chart Figure}) \times \frac{(\text{Ft. of Hose})}{100} = \text{Pressure drop for hose used}$$

Technical Data

This chart is for approximating and should only serve as a guide in sizing air hose. Pressure drop is directly proportional to hose lengths. That means that if hose length doubles, for example, pressure drop doubles.

Example:

- 100 ft. x 1/2 in. i.d. hose at 40 cfm has a pressure loss of 17.5 psi.
- 200 ft. x 1/2 in. i.d. will lose 35 psi.
- 50 ft. x 1/2 in. i.d. will lose between 8 to 9 psi.

E.V.A. = Ethylene Vinyl Acetate E.P.D.M. = Ethylene Propylene Diene Rubber s.s. = Stainless steel
Steel pltd = Steel plated Brass pltd = Brass plated n/a = Not available

Hose, Connections & Assemblies

Technical Data

Chemical Resistance Chart

| TYPES OF SOLVENTS, THINNERS, CATALYSTS | FLUIDALL™ FLUID HOSE | HIGH PRESSURE AIRLESS | Nylon TUBING | POLYETHYLENE TUBING |
|--|----------------------|-----------------------|--------------|---------------------|
| Drying Oils, Alkyds (Mineral Spirits)(Naphtha) | ●■ | ●■ | ●■ | ● |
| Phenolic Varnishes, Epoxy Esters Coal Tars, 1 Pkg. Urethanes (Naphtha – Toluene Blend) | ●■ | ●■ | ●■ | ● |
| Chlorinated Rubber, Chlor. Rub. Zinc Rich Silicones, "Hypalon" (Toluene), (Xylene) | ●■ | ●■ | ●■ | ○ |
| Phenolics, Epoxies, Epoxy Zinc Rich Vinyl Alkyds (Toluene – MEK Blend) | ●■ | ●■ | ●■ | ○ |
| Vinyls, Vinyl-Acrylics, Polyesters, Polyester Zinc Rich, (MEK), (MIBK) | ●■ | ●■ | ●■ | ○ |
| Lacquers, 2 Pkg. Urethanes High Gloss Enamels (Ketone – Ester Blend) | ●■ | ●■ | ●■ | ○ |
| PV Acetate, Polyacrylics Latex, Zinc Silicates, (Water Based) | ● | ● | ● | ● |
| Water-Based | ● | ● | ● | - |
| Aromatic, Solvent Based | - | ● | - | - |
| Chlorinated, Solvent Based | ● | ● | ● | - |

KEY TO CHART:

Material at Room Temperature: ● Continuous Service ○ Intermittent Service **Heated Material:** ■ Continuous Service

Common Terms

| | | | |
|--------|--------------------------|-------------------------------|--------------------------|
| (f) | Female Thread | sw | Swivel |
| (fbe) | Female Both Ends | mwp | Maximum Working Pressure |
| (m) | Male Thread | mpa | ? x 145 = P.S.I. |
| (mbe) | Male Both Ends | | |
| cfm | Cubic Feet Per Minute | Metric Conversion | |
| i.d. | Inside Diameter | 1 cm. = 0.3937 in. | |
| J.I.C. | Joint Industrial Council | 1 bar = 14.5 psi. | |
| nps | National Pipe Straight | 1 liter = 0.264 gal. (U.S.) | |
| npt | National Pipe Tapered | 1 kg. = 2.205 lb. | |
| o.d. | Outside Diameter | 1 meter = 3.28 ft. | |
| psi | Pounds Per Square Inch | 1 millimeter = 0.03937 inches | |
| s.s. | Stainless Steel | | |

E.V.A. = Ethylene Vinyl Acetate E.P.D.M. = Ethylene Propylene Diene Rubber s.s. = Stainless steel
Steel pltd = Steel plated Brass pltd = Brass plated n/a = Not available

Hose, Connections & Assemblies

Premium Spray Finishing Air Hose (Smooth Cover)

Recommended Use

Premium spray finishing air hose. Class B oil resistance. Designed for all finishing operations as well as rugged industrial applications, especially applications requiring lubricants in the airline supply or where oil and grease are present in the environment. Excellent for use with water and water-based materials. Temperature range from -40°F to +200° F (max).

Tube

EPDM, Class B oil resistant.

Reinforcement

High tensile strength spiral reinforcement. Specially designed for maximum flexibility (under pressure) and maximum coupling retention.

Cover

EPDM, red, smooth.
Abrasion resistant. Oil resistant.



Bulk Hose Chart – Smooth Cover

| SIZES AVAILABLE | | BULK HOSE NUMBER | MAXIMUM WORKING PRESSURE (psi) | BEND RADIUS | STD. REEL | APPROX. SHIPPING WEIGHT | |
|-----------------|--------|------------------|--------------------------------|-------------|---------------|-------------------------|------------------------|
| I.D. | o.d. | | | | LENGTH IN FT. | 1 PIECE REELS | BASED ON FEET PER REEL |
| 1/4" | 1/2" | 71-10000 | 250 | 2 3/4" | 500 | 50 lbs. | 10 lbs. |
| 5/16" | 5/8" | 71-11000 | 250 | 3" | 500 | 87 lbs. | 16.2 lbs. |
| 3/8" | 11/16" | 71-12000 | 250 | 3 1/2" | 500 | 96 lbs. | 18 lbs. |
| 1/2" | 7/8" | 71-13000 | 250 | 5" | 300 | 86 lbs. | 26.8 lbs. |
| 3/4" | 1 1/8" | 71-14000 | 250 | 6" | 300 | 112 lbs. | 35 lbs. |

Air Hose Grounded with Static Wire

Recommended Use

Premium finishing air hose. Oil resistance, rating Class B. Designed for all finishing operations as well as rugged industrial applications. Static wire between tube and cover prevents build-up of static electricity. Commonly used with atomizing spray guns, electrostatic spray guns and equipment that requires grounding for safety purposes. Temperature range from -40° F to +200° F.

Tube

EPDM, Class B oil resistant.

Reinforcement

High tensile strength synthetic spiral reinforcement. Specially designed for maximum flexibility (under pressure) and maximum coupling retention.

Cover

EPDM, red, smooth.
Abrasion resistant. Oil resistant.



Bulk Hose Chart – Smooth Cover

| SIZES AVAILABLE | | BULK HOSE NUMBER | MAXIMUM WORKING PRESSURE (psi) | BEND RADIUS | STD. REEL | APPROX. SHIPPING WEIGHT | |
|-----------------|-------|------------------|--------------------------------|-------------|---------------|-------------------------|------------------------|
| I.D. | o.d. | | | | LENGTH IN FT. | 1 PIECE REELS | BASED ON FEET PER REEL |
| 5/16" | .618" | 71-20000 | 250 | 3" | 500 | 87 lbs. | 17.4 lbs. |
| 3/8" | .701" | 71-21000 | 250 | 3.5" | 500 | 96 lbs. | 19.2 lbs. |

Recommended hose connection 72-1317-1/4" nps(f), 72-1325-1/4" nps(f)

E.V.A. = Ethylene Vinyl Acetate E.P.D.M. = Ethylene Propylene Diene Rubber s.s. = Stainless steel
Steel pltd = Steel plated Brass pltd = Brass plated n/a = Not available

Hose, Connections & Assemblies

Connections for Premium & Static Wire Air Hose

| Hose Size | | For Bulk Hose No. | Connections | | Type |
|---------------------------------------|---------|----------------------|-----------------|----------|------|
| i.d. | o.d. | | Thread | Part No. | |
| 1/4" | 1/2" | 71-10000 | 1/4" nps(f) | 72-1303 | A |
| | | | 3/8" nps(f) | 72-1306 | A |
| | | | 3/8" nps(f)s.s. | 72-2143* | A |
| 5/16" | 5/8" | 71-11000 71-20000 | 1/4" nps(f) | 72-1317 | A |
| | | | 1/4" npt(m) | 72-1478 | B |
| | | | 3/8" nps(f) | 72-1320 | A |
| 3/8" | 11/16" | 71-12000 | 1/4" nps(f) | 72-1325 | A |
| | | | 3/8" nps(f) | 72-1328 | A |
| | | | 3/8" nps(f)s.s. | 72-2146* | A |
| 1/2" | 7/8" | 71-13000 | 3/8" nps(f) | 72-1333 | A |
| | | | 1/2" nps(f) | 72-1334 | A |
| | | | 1/2" nps(f) | 72-954†* | C |
| 3/4" | 1 3/16" | 71-14000 | 3/4" nps(f) | 72-1336† | C |
| | | | 3/4" nps(f) | 72-417† | C |
| | | | 3/4" nps(f) | 72-955†* | C |
| Ergoflex™ Air Hose Connections | | | | | |
| 3/8" | .646" | 71-31000 | 1/4" nps(f) | 72-2008 | A |



Type A. Plated Brass



Type B. Plated Brass



Type C. Plated Brass

†Punch-Lok Connection *Stainless Steel tailpiece

For Connection Sleeves, see Tech Sheet #77-5374.

SEE PAGE 5-12 FOR PREMIUM & STATIC WIRE AIR HOSE ASSEMBLIES

E.V.A. = Ethylene Vinyl Acetate E.P.D.M. = Ethylene Propylene Diene Rubber s.s. = Stainless steel
 Steel pltd = Steel plated Brass pltd = Brass plated n/a = Not available

Hose, Connections & Assemblies

Lightweight ErgoFlex™ Air Hose (Smooth Cover)

Recommended Use

Binks ErgoFlex™ HLVP Hose is suitable for use with all kinds of air-operated equipment, including those requiring lubricant in the air line, or in environments where oil and grease are present. Temperature range from -40° F to +200° F (max).



Tube

Black EPDM, Class B oil resistant.

Reinforcement

Synthetic yarn – Spiral reinforcement.

Cover

Tan EPDM, smooth, Class C oil resistant.

Bulk Hose Chart – Smooth Cover

| SIZES AVAILABLE | | BULK HOSE NUMBER | MAXIMUM WORKING PRESSURE (psi) | BEND RADIUS | STD. REEL | APPROX. | HOSE WEIGHT PER 100 FEET |
|-----------------|-------|------------------|--------------------------------|-------------|-----------------------------|--|--------------------------|
| I.D | o.d. | | | | LENGTH IN FT. 1 PIECE REELS | SHIPPING WEIGHT BASED ON FEET PER REEL | |
| 3/8" | .646" | 71-31000 | 125 | 3 1/2" | 500 | 70 lbs. | 12.8 lbs. |

Connections for Ergoflex™ Air Hose

| Hose Size | | For Bulk Hose No. | Connections | | Type |
|-----------|-------|-------------------|-------------|----------|------|
| i.d. | o.d. | | Thread | Part No. | |
| 3/8" | .646" | 71-31000 | 1/4" nps(f) | 72-2008 | A |

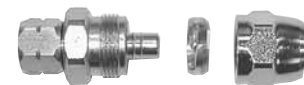

Type A. Plated Brass

SEE PAGE 5-13 FOR ERGOFLEX™ HOSE ASSEMBLIES

E.V.A. = Ethylene Vinyl Acetate E.P.D.M. = Ethylene Propylene Diene Rubber s.s. = Stainless steel
 Steel pltd = Steel plated Brass pltd = Brass plated n/a = Not available

Hose, Connections & Assemblies

Fluidall™ Fluid Hose (Nylon Lined, Maximum Versatility)

Recommended Use

Premium, versatile fluid hose, for finishing operations plus a wide range of fluid applications. Fluidall™ is ideal for resins and solvents contained in epoxies, urethanes, alkyds, primers, acrylics, polyesters, silicones, bitumastic coatings, oil and water based paints, lacquers, alcohol and latex coatings. Temperature range from 0° F to +190°F (max).



Tube

Nylon.

Reinforcement

High tensile synthetic braid. Specially designed for maximum flexibility (under pressure) and maximum coupling retention.

Cover

Black, synthetic, smooth rubber. Class B oil resistant.

Bulk Hose Chart – Smooth Cover

| SIZES AVAILABLE | | BULK HOSE NUMBER | MAXIMUM WORKING PRESSURE (psi) | BEND RADIUS | STD. REEL | APPROX. | HOSE WEIGHT PER 100 FEET |
|-----------------|---------|------------------|--------------------------------|-------------|-----------------------------|--|--------------------------|
| I.D. | o.d. | | | | LENGTH IN FT. 1 PIECE REELS | SHIPPING WEIGHT BASED ON FEET PER REEL | |
| 1/4" | 1/2" | 71-280 | 500 | 3" | 500 | 43 lbs. | 8 lbs. |
| 3/8" | 11/16" | 71-282 | 500 | 3 1/2" | 500 | 83 lbs. | 15 lbs. |
| 1/2" | 7/8" | 71-283 | 750 | 5" | 300 | 74 lbs. | 22 lbs. |
| 3/4" | 1 3/16" | 71-284 | 750 | 8" | 300 | 118 lbs. | 36 lbs. |
| 1" | 1 1/2" | 71-285 | 750 | 12" | 300 | 168 lbs. | 53 lbs. |

Connections for Fluidall™ Fluid Hose

| Hose Size | | For Bulk Hose No. | Connections | | Type |
|-----------|---------|-------------------|-----------------|----------|------|
| i.d. | o.d. | | Thread | Part No. | |
| 1/4" | 1/2" | 71-280 | 1/4" nps(f) | 72-1303 | A |
| | | | 3/8" nps(f) | 72-1306 | A |
| | | | 3/8" nps(f)s.s. | 72-2143* | A |
| 3/8" | 11/16" | 71-282 | 1/4" nps(f) | 72-1325 | A |
| | | | 3/8" nps(f) | 72-1328 | A |
| | | | 3/8" nps(f)s.s. | 72-2146* | A |
| 1/2" | 7/8" | 71-283 | 3/8" nps(f) | 72-1333 | A |
| | | | 1/2" nps(f) | 72-1334 | A |
| | | | 1/2" nps(f) | 72-954†* | C |
| 3/4" | 1 3/16" | 71-284 | 3/4" nps(f) | 72-1336† | C |
| | | | 3/4" nps(f) | 72-417† | C |
| | | | 3/4" nps(f) | 72-955†* | C |
| 1" | 1 1/2" | 71-285 | 1" nps(f) | 72-418† | C |
| | | | 1" nps(f) | 72-956* | C |

†Punch-Lok Connection *Stainless Steel tailpiece



Type A. Plated Brass



Type B. Plated Brass



Type C. Plated Brass

SEE PAGE 5-14 FOR FLUIDALL™ HOSE ASSEMBLIES

E.V.A. = Ethylene Vinyl Acetate E.P.D.M. = Ethylene Propylene Diene Rubber s.s. = Stainless steel
Steel pltd = Steel plated Brass pltd = Brass plated n/a = Not available

Hose, Connections & Assemblies

Tubing & Connections

Nylon Tubing & Connections

| Size | Tubing No. | Max. Working Pressure (psi) | | Connection Part No. | Connection Description | Type |
|------------------------|------------|-----------------------------|---------------|---------------------|--|------|
| | | @ 70 DEG. F. | @ 150 DEG. F. | | | |
| 1/8" i.d. x .225" o.d. | 71-226 | 475 | 190 | PLH-1838-SS | s.s. 3/8" nps(f) swivel | E |
| | | | | 72-1677 | Brass 1/4" nps(f) swivel | E |
| 3/16" i.d. x 1/4" o.d. | 71-230 | 225 | 190 | PLH-31638-SS | s.s. 3/8" nps(f) swivel | E |
| | | | | 72-1729 | Brass 3/8" nps(f) swivel | E |
| | | | | 72-1793 | s.s. 3/8" nps(f) swivel w/ spring guard | D |
| | | | | 72-1679 | Brass 1/4" nps(f) swivel | E |
| | | | | 72-1747 | Brass 1/4" nps(f) swivel w. Spring guard | D |
| | | | | 72-1789 | s.s. 1/4" nps(f) swivel | E |
| | | | | 72-1792 | s.s. 1/4" nps(f) swivel w. Spring guard | D |
| 1/4" i.d. x .350" o.d. | 71-227 | 225 | 190 | 72-1680 | Brass 1/8" npt(m) | E |
| | | | | 72-1681 | Brass 1/4" nps(f) swivel | E |
| | | | | 72-1683 | Brass 3/8" nps(f) swivel | E |
| | | | | 72-1687 | Brass 1/4" nps(f) swivel w/ spring guard | D |
| | | | | 72-1689 | Brass 3/8" nps(f) swivel w/ spring guard | D |
| | | | | 72-1799 | s.s. 1/4" nps(f) swivel | E |
| | | | | 72-1800 | s.s. 1/4" nps(f) swivel w/ spring guard | D |
| | | | | 72-1801 | s.s. 3/8" nps(f) swivel | E |
| | | | | 72-1802 | s.s. 3/8" nps(f) swivel w/ spring guard | D |
| 3/8" i.d. x 1/2" o.d. | 71-229 | 200 | 140 | 72-1685 | Brass 3/8" nps(f) swivel | E |
| | | | | 72-1811 | s.s. 1/4" nps(f) swivel | E |
| | | | | 72-1812 | s.s. 3/8" nps(f) swivel | E |



TYPE D
Plated brass or stainless steel



TYPE E
Plated brass or stainless steel

SEE PAGE 5-16 FOR NYLON TUBE ASSEMBLIES

E.V.A. = Ethylene Vinyl Acetate E.P.D.M. = Ethylene Propylene Diene Rubber s.s. = Stainless steel
Steel pltd = Steel plated Brass pltd = Brass plated n/a = Not available

5

Hose, Connections & Assemblies

Tubing & Connections

Polyethylene Tubing & Connections

| Size | Tubing No. | Max. Working Pressure (psi) | Connection Part No. | Connection Description | Type |
|------------------------|------------|-----------------------------|---------------------|---|------|
| .175" i.d. x 1/4" o.d. | H-2339 | 125 | P-HC-4728 | Brass-alum-steel 1/4" nps(f) swivel | E |
| | | | P-HC-4221 | Brass-alum-steel 1/4" nps(f) swivel w/ spring guard | D |
| 1/4" i.d. x 3/8" o.d. | H-2338 | 125 | 72-1579 | Brass 1/4" nps(f) swivel | E |
| | | | 72-1581 | Brass 3/8" nps(f) swivel | E |
| | | | 72-1583 | Brass 1/4" nps(f) swivel w/ spring guard | D |
| | | | 72-1585 | Brass 3/8" nps(f) swivel w/ spring guard | D |
| | | | 72-1839 | s.s. 3/8" nps(f) swivel | E |
| | | | 72-1968 | s.s. 1/4" nps(f) swivel | E |
| | | | 72-1983 | s.s. 1/4" nps(f) swivel w/ spring guard | D |
| | | | 72-2060 | s.s. 3/8" nps(f) swivel w/ spring guard | D |

5

E.V.A. Tubing & Connections

| Size | Tubing No. | Max. Working Pressure (psi) | Connection Part No. | Connection Description | Type |
|--------------------------|------------|-----------------------------|-----------------------------------|--|------|
| 1/8" i.d. x 5/16" o.d. | 71-201 | 100 | 102-3031 | 316 s.s. 1/4" (f) swivel w/spring guard | D |
| 5/16" i.d. X 17/32" o.d. | 71-508 | 250 | 72-1646 | 416 s.s. 1/4" nps(f) swivel w/spring guard | D |
| 3/8" i.d. x 19/32" o.d. | 71-509 | 250 | 102-3033 connection & 72-1367 nut | 316 s.s. 3/8" nps(f) | E |



TYPE D
Plated brass or stainless steel



TYPE E
Plated brass or stainless steel

SEE PAGE 5-21 FOR E.V.A. HOSE ASSEMBLIES

E.V.A. = Ethylene Vinyl Acetate E.P.D.M. = Ethylene Propylene Diene Rubber s.s. = Stainless steel
Steel pltd = Steel plated Brass pltd = Brass plated n/a = Not available

Hose, Connections & Assemblies

Tubing & Connections

Teflon Tubing & Connections

| Size | Tubing No. | Max. Working Pressure (psi) | Connection Part No. | Connection Description | Type |
|-------------------------|-----------------------|-----------------------------|---------------------|--|------|
| 1/4" i.d. x 3/8" o.d. | 71-204 | 140 | 72-1579 | Brass 1/4" nps(f) swivel | E |
| | | | 72-1581 | Brass 3/8" nps(f) swivel | E |
| | | | 72-1583 | Brass 1/4" nps(f) swivel w/ spring guard | D |
| | | | 72-1585 | Brass 3/8" nps(f) swivel w/ spring guard | D |
| | | | 72-1839 | s.s. 3/8" nps(f) swivel | E |
| | | | 72-1968 | s.s. 1/4" nps(f) swivel | E |
| | | | 72-1983 | s.s. 1/4" nps(f) swivel w/ spring guard | D |
| | | | 72-2060 | s.s. 3/8" nps(f) swivel w/ spring guard | D |
| | | | 54-4976 | Push-lok 1/4" nps(f)* | E |
| 54-4975 | Push-lok 1/8" npt(m)* | E | | | |
| *plastic & plated steel | | | | | |
| 1/8" i.d. x 1/4" o.d. | 71-248 | 140 | 72-1944 | Brass 1/4" nps(f) swivel | E |
| | | | 72-1945 | s.s. 3/8" nps(f) swivel | E |
| 3/16" i.d. x 5/16" o.d. | 71-209 | 140 | 72-1577 | Brass 1/4" nps(f) swivel | E |
| | | | 72-1730 | Brass 3/8" nps(f) swivel | E |
| 3/8" i.d. x 1/2" o.d. | 71-207 | 140 | 72-1685 | Brass 3/8" nps(f) swivel | E |
| | | | 72-1811 | s.s. 1/4" nps(f) swivel | E |
| | | | 72-1812 | s.s. 3/8" nps(f) swivel | E |

5

Polyurethane Tubing & Connections

| Size | Tubing No. | Max. Working Pressure (psi) | Connection Part No. | Connection Description | Type |
|-----------------------|------------|-----------------------------|---------------------|--|------|
| 1/4" i.d. x 3/8" o.d. | 54-4987 | 100 | 54-4976 | Push-lok 1/4" nps(f)* | — |
| | | | 54-4975 | Push-lok 1/8" npt(m)* | — |
| | | | 72-1579 | Brass 1/4" nps(f) swivel | E |
| | | | 72-1583 | Brass 1/4" nps(f) swivel w/ spring guard | D |

*plastic & plated steel



TYPE D
Plated brass or stainless steel



TYPE E
Plated brass or stainless steel

**SEE PAGE 5-13 FOR
POLYURETHANE TUBE
ASSEMBLIES**

E.V.A. = Ethylene Vinyl Acetate E.P.D.M. = Ethylene Propylene Diene Rubber s.s. = Stainless steel
Steel pltd = Steel plated Brass pltd = Brass plated n/a = Not available

Hose, Connections & Assemblies

Air Hose Assemblies

Premium Air Hose Assemblies (Low Pressure)

| Part Number | Bulk Hose No. | Size | Max. Working Pressure | Tube Material | Connection Part No. | Threads | Connection Material |
|-------------|---------------|----------------------------------|-----------------------|---------------|---------------------|-------------|---------------------|
| 71-1101 | 71-10000 | 1/4" i.d. x 1/2" o.d. x 5 ft. | 250 psi | E.P.D.M. | 72-1303 | 1/4" nps(f) | Brass pltd |
| 71-1105 | 71-10000 | 1/4" i.d. x 1/2" o.d. x 25 ft. | 250 psi | E.P.D.M. | 72-1303 | 1/4" nps(f) | Brass pltd |
| 71-1106 | 71-10000 | 1/4" i.d. x 1/2" o.d. x 50 ft. | 250 psi | E.P.D.M. | 72-1303 | 1/4" nps(f) | Brass pltd |
| 71-1201 | 71-11000 | 5/16" i.d. x 5/8" o.d. x 5 ft. | 250 psi | E.P.D.M. | 72-1317 | 1/4" nps(f) | Brass pltd |
| 71-1203 | 71-11000 | 5/16" i.d. x 5/8" o.d. x 15 ft. | 250 psi | E.P.D.M. | 72-1317 | 1/4" nps(f) | Brass pltd |
| 71-1205 | 71-11000 | 5/16" i.d. x 5/8" o.d. x 25 ft. | 250 psi | E.P.D.M. | 72-1317 | 1/4" nps(f) | Brass pltd |
| 71-1206 | 71-11000 | 5/16" i.d. x 5/8" o.d. x 50 ft. | 250 psi | E.P.D.M. | 72-1317 | 1/4" nps(f) | Brass pltd |
| 71-1209 | 71-11000 | 5/16" i.d. x 5/8" o.d. x 6 ft. | 250 psi | E.P.D.M. | 72-1317 | 1/4" nps(f) | Brass pltd |
| 71-1355 | 71-12000 | 3/8" i.d. x 11/16" o.d. x 25 ft. | 250 psi | E.P.D.M. | 72-1325 | 1/4" nps(f) | Brass pltd |
| 71-1356 | 71-12000 | 3/8" i.d. x 11/16" o.d. x 50 ft. | 250 psi | E.P.D.M. | 72-1325 | 1/4" nps(f) | Brass pltd |

Air Hose Assemblies (Grounded with Static Wire)

| Part Number | Bulk Hose No. | Size | Max. Working Pressure | Tube Material | Connection Part No. | Threads | Connection Material |
|-------------|---------------|---------------------------------|-----------------------|---------------|---------------------|-------------|---------------------|
| 71-2803 | 71-20000 | 5/16" i.d. x 5/8" o.d. x 25 ft. | 250 psi | E.P.D.M. | 72-1317 | 1/4" nps(f) | Brass pltd |
| 71-2810 | 71-20000 | 5/16" i.d. x 5/8" o.d. x 35 ft. | 250 psi | E.P.D.M. | 72-1317 | 1/4" nps(f) | Brass pltd |
| 71-2804 | 71-20000 | 5/16" i.d. x 5/8" o.d. x 50 ft. | 250 psi | E.P.D.M. | 72-1317 | 1/4" nps(f) | Brass pltd |

E.V.A. = Ethylene Vinyl Acetate E.P.D.M. = Ethylene Propylene Diene Rubber s.s. = Stainless steel
 Steel pltd = Steel plated Brass pltd = Brass plated n/a = Not available

Hose, Connections & Assemblies

Air Hose Assemblies

Ergoflex Air Hose Assemblies

| Part Number | Bulk Hose No. | Size | Max. Working Pressure | Tube Material | Connection Part No. | Threads | Connection Material |
|-------------|---------------|--------------------------------|-----------------------|---------------|---------------------|------------|---------------------|
| 71-31101 | H-3670 | .390 i.d. x .650 o.d. x 25 ft. | 200 psi | E.P.D.M. | 72-2008 | 1/4"nps(f) | Brass pltd |
| 71-31103 | H-3670 | .390 i.d. x .650 o.d. x 6 ft. | 200 psi | E.P.D.M. | 72-2008 | 1/4"nps(f) | Brass pltd |

1/4" I.D. Air Tubing Assemblies (Low Pressure – Air Assist Supply)

| Part Number | Bulk Hose No. | Size | Max. Working Pressure | Tube Material | Connection Part No. | Threads | Connection Material |
|-------------|---------------|--------------------------------|-----------------------|--------------------|--------------------------|------------|---------------------|
| 54-4989 | 54-4987 | 1/4" i.d. x 3/8" o.d. x 25 ft. | 100 psi | Polyurethane (red) | none | n/a | n/a |
| 71-4800 | 54-4987 | 1/4" i.d. x 3/8" o.d. x 35 ft. | 100 psi | Polyurethane (red) | none | n/a | n/a |
| 71-4801 | 54-4987 | 1/4" i.d. x 3/8" o.d. x 50 ft. | 100 psi | Polyurethane (red) | none | n/a | n/a |
| 71-4803 | 54-4987 | 1/4" i.d. x 3/8" o.d. x 28 ft. | 100 psi | Polyurethane (red) | none | n/a | n/a |
| 71-4991 | 54-4987 | 1/4" i.d. x 3/8" o.d. x 25 ft. | 100 psi | Polyurethane (red) | 54-4976 Tubing connector | 1/4"npt(f) | Brass pltd |

1/8" I.D. Air Hose Assemblies (for Wren Airbrush)

| Part Number | Bulk Hose No. | Size | Max. Working Pressure | Tube Material | Connection Part No. | Threads | Connection Material |
|-------------|---------------|--------------------------------|-----------------------|---------------|---------------------|-------------------------|---------------------|
| 59-61 | 71-113 | 1/8" i.d. x 5/16" o.d. x 6 ft. | 250 psi | Rubber | 72-93 x 59-50 | 1/4"nps(f) x 1/4"-40(f) | Brass pltd |

Breathable Air Hose Assemblies (For MPV Air Respirator)

| Part Number | Bulk Hose No. | Size | Max. Working Pressure | Tube Material | Connection Part No. | Threads | Connection Material |
|-------------|---------------|-----------------------|-----------------------|---------------|---------------------|----------------|---------------------|
| MPV-457 | n/a | (see note) | n/a | n/a | n/a | n/a | n/a |
| MPV-530 | n/a | 5/16" i.d. (see note) | 250 psi | Rubber | n/a | male stem / QD | Steel pltd |
| MPV-550 | n/a | 5/16" i.d. (see note) | 250 psi | Rubber | n/a | male stem / QD | Steel pltd |

Note: These MPV hose assemblies are used with the MPV-625 Air Supplied Respirator only, and are NIOSH approved. Alternate hoses must not be substituted. Otherwise, NIOSH approval will be void, and an unsafe condition may result.

E.V.A. = Ethylene Vinyl Acetate E.P.D.M. = Ethylene Propylene Diene Rubber s.s. = Stainless steel
 Steel pltd = Steel plated Brass pltd = Brass plated n/a = Not available

Hose, Connections & Assemblies

Fluid Hose Assemblies

Fluidall™ Hose Assemblies (Low Pressure)

| Part Number | Bulk Hose No. | Size | Max. Working Pressure | Tube Material | Connection Part No. | Threads | Connection Material |
|-------------|---------------|----------------------------------|-----------------------|---------------|---------------------|-------------|---------------------|
| 71-3260 | 71-280 | 1/4" i.d. x 1/2" o.d. x 5 ft. | 500 psi | Nylon | 72-1303 | 1/4" nps(f) | Brass pltd |
| 71-3279 | 71-280 | 1/4" i.d. x 1/2" o.d. x 9" | 500 psi | Nylon | 72-1303 | 1/4" nps(f) | Brass pltd |
| 71-3380 | 71-280 | 1/4" i.d. x 1/2" o.d. x 5 ft. | 500 psi | Nylon | 72-1306 | 3/8" nps(f) | Brass pltd |
| 71-3383 | 71-280 | 1/4" i.d. x 1/2" o.d. x 25 ft. | 500 psi | Nylon | 72-1306 | 3/8" nps(f) | Brass pltd |
| 71-3384 | 71-280 | 1/4" i.d. x 1/2" o.d. x 50 ft. | 500 psi | Nylon | 72-1306 | 3/8" nps(f) | Brass pltd |
| 71-3390 | 71-280 | 1/4" i.d. x 1/2" o.d. x 35 ft. | 500 psi | Nylon | 72-1306 | 3/8" nps(f) | Brass pltd |
| 71-3663 | 71-280 | 1/4" i.d. x 1/2" o.d. x 25 ft. | 500 psi | Nylon | 72-2143 | 3/8" nps(f) | s.s. |
| 71-3300 | 71-282 | 3/8" i.d. x 11/16" o.d. x 5 ft. | 500 psi | Nylon | 72-1328 | 3/8" nps(f) | Brass pltd |
| 71-3303 | 71-282 | 3/8" i.d. x 11/16" o.d. x 25 ft. | 500 psi | Nylon | 72-1328 | 3/8" nps(f) | Brass pltd |
| 71-3304 | 71-282 | 3/8" i.d. x 11/16" o.d. x 50 ft. | 500 psi | Nylon | 72-1328 | 3/8" nps(f) | Brass pltd |
| 71-3313 | 71-282 | 3/8" i.d. x 11/16" o.d. x 17" | 500 psi | Nylon | 72-1328 | 3/8" nps(f) | Brass pltd |
| 71-3400 | 71-283 | 1/2" i.d. x 7/8" o.d. x 5 ft. | 750 psi | Nylon | 72-1334 | 1/2" nps(f) | Brass pltd |
| 71-3403 | 71-283 | 1/2" i.d. x 7/8" o.d. x 25 ft. | 750 psi | Nylon | 72-1334 | 1/2" nps(f) | Brass pltd |
| 71-3404 | 71-283 | 1/2" i.d. x 7/8" o.d. x 50 ft. | 750 psi | Nylon | 72-1334 | 1/2" nps(f) | Brass pltd |
| 71-3360 | 71-285 | 1" i.d. x 1 1/2" o.d. x 5 ft. | 750 psi | Nylon | n/a | 1" nps(f) | Brass pltd |
| 71-3361 | 71-285 | 1" i.d. x 1 1/2" o.d. x 10 ft. | 750 psi | Nylon | n/a | 1" nps(f) | Brass pltd |
| 71-3367 | 71-285 | 1" i.d. x 1 1/2" o.d. x 8 ft. | 750 psi | Nylon | n/a | 1" nps(f) | Brass pltd |

E.V.A. = Ethylene Vinyl Acetate E.P.D.M. = Ethylene Propylene Diene Rubber s.s. = Stainless steel
 Steel pltd = Steel plated Brass pltd = Brass plated n/a = Not available

Hose, Connections & Assemblies

Fluid Hose Assemblies

Hose Assembly Sets (Air & Fluid)

| Part Number | Bulk Hose No. | Size | Max. Working Pressure | Tube Material | Connection Part No. | Threads | Connection Material |
|-------------|---------------|---|-----------------------|---------------|---------------------|-------------------|---------------------|
| 6-438 | 71-11000 | 5/16" i.d. x 5/8" o.d. x 25 ft. (air) 71-1205 | 250 psi | Rubber | 72-1317 | 1/4" nps(f) air | Brass pltd |
| | 71-282 | 3/8" i.d. x 11/16" o.d. x 25 ft. (fluid) 71-3303 | 500 psi | Nylon | 72-1328 | 3/8" nps(f) fluid | Brass pltd |
| KB-4006 | 71-11000 | 5/16" i.d. x 5/8" o.d. x 5 ft. 9 in. (air) | 250 psi | Rubber | 72-1317 | 1/4" nps(f) air | Brass pltd |
| | 71-280 | 1/4" i.d. x 1/2" o.d. x 6 ft. 3 in. (fluid) | 500 psi | Nylon | 72-1306 | 3/8" nps(f) fluid | Brass pltd |

Siphon Fluid Hose Assemblies

| Part Number | Bulk Hose No. | Size | Max. Working Pressure | Tube Material | Connection Part No. | Threads | Connection Material |
|-------------|---------------|----------------------------------|-----------------------|---------------|---------------------------------|-----------------------|---------------------|
| 41-11211 | 71-284 | 3/4" i.d. x 1-3/16" o.d. x 5 ft. | 750 psi | Nylon | n/a | 3/4" nps(f) | Steel pltd |
| 41-11216 | 71-284 | 3/4" i.d. x 1-3/16" o.d. x 8 ft. | 750 psi | Nylon | n/a | 3/4" nps(f) | Steel pltd |
| 41-11210 | 71-285 | 1" i.d. x 1-1/2" o.d. x 8 ft. | 750 psi | Nylon | n/a | 1" nps(f) | Steel pltd |
| 41-11212 | 71-285 | 1" i.d. x 1-1/2" o.d. x 5 ft. | 750 psi | Nylon | n/a | 1" nps(f) | Steel pltd |
| 44-1641 | 71-285 | 1" i.d. x 1-1/2" o.d. x 7 ft. | 750 psi | Nylon | (2) 72-2329, 72-2330, 72-415 | (2) 1" nps(f) | s.s. |
| 103-1313 | 71-285 | 1" i.d. x 1 1/2" o.d. x 8 ft. | 750 psi | Nylon | n/a | 1" npt(f) | Steel pltd |
| 103-1349 | 71-285 | 1" i.d. x 1 1/2" o.d. x 8 ft. | 750 psi | Nylon | n/a | 1" npt(f) x 1" npt(f) | Steel pltd |
| 103-1350 | 71-285 | 1" i.d. x 1 1/2" o.d. x 5 ft. | 750 psi | Nylon | n/a | 1" npt(f) x 1" npt(f) | Steel pltd |
| 103-2029 | 71-285 | 1" i.d. x 1 1/2" o.d. x 8 ft. | 750 psi | Nylon | 72-1981 | 1" nps(m) x 1" npt(m) | Steel pltd |

E.V.A. = Ethylene Vinyl Acetate E.P.D.M. = Ethylene Propylene Diene Rubber s.s. = Stainless steel
 Steel pltd = Steel plated Brass pltd = Brass plated n/a = Not available

Hose, Connections & Assemblies

Fluid Hose Assemblies

Nylon Tube Assemblies

| Part Number | Bulk Hose No. | Size | Max. Working Pressure | Tube Material | Connection Part No. | Threads | Connection Material |
|-------------|---------------|---------------------------------|-----------------------|---------------|---------------------|---------------------------|---------------------|
| 71-7686 | 71-230 | 3/16" i.d. x .264 o.d. x 15 ft. | 225 psi | Nylon | 72-1792, 72-1793 | 1/4" nps(f) x 3/8" nps(f) | w/ Spring guards |
| 71-7687 | 71-230 | 3/16" i.d. x .264 o.d. x 25 ft. | 225 psi | Nylon | 72-1793, 72-1792 | 1/4" nps(f) x 3/8" nps(f) | 303 s.s. |
| 71-7797 | 71-229 | 3/8" i.d. x 1/2" o.d. x 15 ft. | 200 psi | Nylon | 72-1812 | 3/8" nps(f) | s.s. |
| 71-7778 | 71-229 | 3/8" i.d. x 1/2" o.d. x 25 ft. | 200 psi | Nylon | 72-1812 | 3/8" nps(f) | s.s. |

Fluid Hose Drains (Low Pressure) (connection one end)

| Part Number | Bulk Hose No. | Size | Max. Working Pressure | Tube Material | Connection Part No. | Threads | Connection Material |
|-------------|---------------|-------------------------------|-----------------------|---------------|---------------------|-------------|---------------------|
| 71-7328 | 71-227 | 1/4" i.d. x .350 o.d. x 23" | 225 psi | Nylon | 72-63, 72-93 | 1/4" nps(f) | Brass pltd |
| 71-7332 | 71-227 | 1/4" i.d. x .350 o.d. x 3 ft. | 225 psi | Nylon | 72-63, 72-93 | 1/4" nps(f) | Brass pltd |

Contractor Quality Airless Paint Hose (Conductive – No Wire)

| Part Number | Bulk Hose No. | Size | Max. Working Pressure | Tube Material | Connection Part No. | Threads | Connection Material |
|-------------|---------------|--------------------|-----------------------|---------------|---------------------|-------------|---------------------|
| 71-3530 | n/a | 1/4" i.d. x 25 ft. | 3300 psi | Nylon | n/a | 1/4" nps(f) | Steel pltd |
| 71-3531 | n/a | 1/4" i.d. x 50 ft. | 3300 psi | Nylon | n/a | 1/4" nps(f) | Steel pltd |

E.V.A. = Ethylene Vinyl Acetate E.P.D.M. = Ethylene Propylene Diene Rubber s.s. = Stainless steel
 Steel pltd = Steel plated Brass pltd = Brass plated n/a = Not available

Hose, Connections & Assemblies

Fluid Hose Assemblies

Premium Airless Paint Hose (Conductive – No Wire)

| Part Number | Bulk Hose No. | Size | Max. Working Pressure | Tube Material | Connection Part No. | Threads | Connection Material |
|--------------------------------|---------------|---------------------|-----------------------|---------------|----------------------------|-------------|---------------------|
| 71-8085 | n/a | 3/16" i.d. x 5 ft. | 3000 psi | Nylon | Permanent w/ spring guards | 1/4" nps(f) | Steel pltd |
| 71-8088 | n/a | 3/16" i.d. x 25 ft. | 3000 psi | Nylon | Permanent w/ spring guards | 1/4" nps(f) | Steel pltd |
| 71-8089 | n/a | 3/16" i.d. x 50 ft. | 3000 psi | Nylon | Permanent w/ spring guards | 1/4" nps(f) | Steel pltd |
| 71-7703 | n/a | 1/4" i.d. x 15 ft. | 3000 psi | Nylon | Permanent w/ spring guards | 1/4" nps(f) | Steel pltd |
| 71-7704 (OBS – use 71-4830) | n/a | 1/4" i.d. x 25 ft. | 3000 psi | Nylon | Permanent w/ spring guards | 1/4" nps(f) | Steel pltd |
| 71-7705 | n/a | 1/4" i.d. x 50 ft. | 3000 psi | Nylon | Permanent w/ spring guards | 1/4" nps(f) | Steel pltd |
| 71-7708 | n/a | 1/4" i.d. x 5 ft. | 3000 psi | Nylon | Permanent w/ spring guards | 1/4" nps(f) | Steel pltd |
| 71-7709 | n/a | 1/4" i.d. x 10 ft. | 3000 psi | Nylon | Permanent w/ spring guards | 1/4" nps(f) | Steel pltd |
| 71-7504 | n/a | 5/16" i.d. x 25 ft. | 3000 psi | Nylon | Permanent w/ spring guards | 1/4" nps(f) | Steel pltd |
| 71-7505 | n/a | 5/16" i.d. x 50 ft. | 3000 psi | Nylon | Permanent w/ spring guards | 1/4" nps(f) | Steel pltd |
| 71-7508 | n/a | 5/16" i.d. x 35 ft. | 3000 psi | Nylon | Permanent w/ spring guards | 1/4" nps(f) | Steel pltd |
| 71-8421 | n/a | 3/8" i.d. x 5 ft. | 3000 psi | Nylon | Permanent w/ spring guards | 3/8" nps(f) | Steel pltd |
| 71-8424 | n/a | 3/8" i.d. x 25 ft. | 3000 psi | Nylon | Permanent w/ spring guards | 3/8" nps(f) | Steel pltd |
| 71-8425 | n/a | 3/8" i.d. x 50 ft. | 3000 psi | Nylon | Permanent w/ spring guards | 3/8" nps(f) | Steel pltd |

E.V.A. = Ethylene Vinyl Acetate E.P.D.M. = Ethylene Propylene Diene Rubber s.s. = Stainless steel
 Steel pltd = Steel plated Brass pltd = Brass plated n/a = Not available

Hose, Connections & Assemblies

Fluid Hose Assemblies

PIT BULL™ Airless Paint Hose (Conductive)

| Part Number | Bulk Hose No. | Size | Max. Working Pressure | Tube Material | Connection Type | Threads | Connection Material |
|-------------|---------------|--------------------|-----------------------|----------------|----------------------------|-------------|---------------------|
| 71-4830 | n/a | 1/4" i.d. x 25 ft. | 4000 psi | Nylon (Yellow) | Permanent w/ spring guards | 1/4" nps(f) | Steel pltd |
| 71-4831 | n/a | 1/4" i.d. x 50 ft. | 4000 psi | Nylon (Yellow) | Permanent w/ spring guards | 1/4" nps(f) | Steel pltd |
| 71-4840 | n/a | 1/4" i.d. x 25 ft. | 10,000 psi | Nylon (Yellow) | Permanent w/ spring guards | 1/4" nps(f) | Steel pltd |
| 71-4841 | n/a | 1/4" i.d. x 50 ft. | 10,000 psi | Nylon (Yellow) | Permanent w/ spring guards | 1/4" nps(f) | Steel pltd |
| 71-4850 | n/a | 3/8" i.d. x 25 ft. | 3500 psi | Nylon (Yellow) | Permanent w/ spring guards | 3/8" nps(f) | Steel pltd |
| 71-4851 | n/a | 3/8" i.d. x 50 ft. | 3500 psi | Nylon (Yellow) | Permanent w/ spring guards | 3/8" nps(f) | Steel pltd |
| 71-4860 | n/a | 3/8" i.d. x 25 ft. | 8000 psi | Nylon (Yellow) | Permanent w/ spring guards | 3/8" nps(f) | Steel pltd |
| 71-4861 | n/a | 3/8" i.d. x 50 ft. | 8000 psi | Nylon (Yellow) | Permanent w/ spring guards | 3/8" nps(f) | Steel pltd |

PIT BULL™ Whip-End Fluid Hose Assemblies

| Part Number | Bulk Hose No. | Size | Max. Working Pressure | Tube Material | Connection Type | Threads | Connection Material |
|-------------|---------------|-------------------|-----------------------|----------------|----------------------------|---------------------------|---------------------|
| 71-4870 | n/a | 1/4" i.d. x 3 ft. | 10,000 psi | Nylon (Yellow) | Permanent w/ spring guards | 3/8" nps(m) x 1/4" nps(f) | Steel pltd |
| 71-4871 | n/a | 1/4" i.d. x 3 ft. | 10,000 psi | Nylon (Yellow) | Permanent w/ spring guards | 1/4" nps(m) x 1/4" nps(f) | Steel pltd |

Whip-End Fluid Hose Assemblies

| Part Number | Bulk Hose No. | Size | Max. Working Pressure | Tube Material | Connection Type | Threads | Connection Material |
|-------------|---------------|-------------------|-----------------------|---------------|----------------------------|---------------------------|---------------------|
| 71-8360 | n/a | 3/16" i.d. x 30" | 3000 psi | Nylon | Permanent w/ spring guards | 1/4" nps(f) x 1/4" npt(m) | Steel pltd |
| 71-6844 | n/a | 1/8" i.d. x 3 ft. | 5000 psi | Nylon | Permanent w/ spring guards | 1/4" nps(f) x 1/4" npt(m) | Steel pltd |

E.V.A. = Ethylene Vinyl Acetate E.P.D.M. = Ethylene Propylene Diene Rubber s.s. = Stainless steel
 Steel pltd = Steel plated Brass pltd = Brass plated n/a = Not available

Hose, Connections & Assemblies

FRP Hose Assemblies

Air-assist Airless Fluid Hose Assemblies

| Part Number | Bulk Hose No. | Size | Max. Working Pressure | Tube Material | Connection Type | Threads | Connection Material |
|-------------|---------------|---------------------|-----------------------|----------------|-----------------------------|-------------|---------------------|
| 71-4992 | n/a | 1/8" i.d. x 15 ft. | 4000 psi | Nylon (Yellow) | Permanent w/o spring guards | 1/4" npt(f) | s.s. |
| 71-4993 | n/a | 1/8" i.d. x 25 ft. | 5000 psi | Nylon (Yellow) | Permanent w/o spring guards | 1/4" nps(f) | s.s. |
| 71-4995 | n/a | 3/16" i.d. x 25 ft. | 1900 psi | Nylon (Blue) | Permanent w/o spring guards | 1/4" nps(f) | s.s. |

Air Hose Assemblies (Low Pressure – FRP)

| Part Number | Bulk Hose No. | Size | Max. Working Pressure | Tube Material | Connection Part No. | Threads | Connection Material |
|-------------|---------------|---------------------------------|-----------------------|---------------|---------------------|-------------------------|---------------------|
| 207-10752-1 | 237-505 | 1/4" i.d. x 1/2" o.d. x 14" | 250 psi | E.V.A. | Permanent | 1/4" nps(f)x1/4" npt(m) | Brass |
| 207-10752-2 | 237-505 | 1/4" i.d. x 1/2" o.d. x 20" | 250 psi | E.V.A. | Permanent | 1/4" nps(f)x1/4" npt(m) | Brass |
| 207-11512-3 | 71-227 | 1/4" i.d. x .350 o.d. x 25 ft. | 225 psi | Nylon | 72-1687 | 1/4" nps(f) | Brass pltd |
| 207-11512-8 | 71-227 | 1/4" i.d. x .350 o.d. x 50 ft. | 225 psi | Nylon | 72-1687 | 1/4" nps(f) | Brass pltd |
| 207-10770-8 | 71-11000 | 5/16" i.d. x 5/8" o.d. x 50 ft. | 250 psi | EPDM | 72-1317 | 1/4" nps(f) | Brass pltd |

Fluid Hose Assemblies (Low Pressure)

| Part Number | Bulk Hose No. | Size | Max. Working Pressure | Tube Material | Connection Part No. | Threads | Connection Material |
|-------------|---------------|-----------------------|-----------------------|---------------|---------------------|-------------------------|---------------------|
| 207-10941-5 | 4282 | 1/2" i.d. x 50 ft. | 2000 psi | Nylon | n/a | 3/4" - 16 J.I.C. sw. | Steel pltd |
| 207-10941-8 | 4282 | 1/2" i.d. x 30" | 2000 psi | Nylon | n/a | 3/4" - 16 J.I.C. sw. | Steel pltd |
| 207-12269-2 | 71-283 | 1/2" i.d. x 7/8" o.d. | 750 psi | Nylon | n/a | 3/4" - 16 J.I.C. sw. | Steel pltd |
| 207-12269-5 | 71-283 | 1/2" i.d. x 7/8" o.d. | 750 psi | Nylon | n/a | 3/4" - 16 J.I.C. sw. | Steel pltd |
| 207-10946-1 | 71-284 | 3/4" i.d. x 6 ft. | 750 psi | Nylon | 4358 | 1 1/16" - 12 J.I.C. sw. | Steel pltd |

E.V.A. = Ethylene Vinyl Acetate E.P.D.M. = Ethylene Propylene Diene Rubber s.s. = Stainless steel
 Steel pltd = Steel plated Brass pltd = Brass plated n/a = Not available

Hose, Connections & Assemblies

FRP Hose Assemblies

Misc. Air/Fluid Hose Assemblies (FRP)

| Part Number | Bulk Hose No. | Size | Max. Working Pressure | Tube Material | Connection Part No. | Threads | Connection Material | Type |
|-------------|---------------|-------------------------------|-----------------------|---------------|-----------------------|---------------------------|---------------------|-----------|
| 207-10910-6 | n/a | 1/2" i.d. x 13/16" o.d. x 18" | 200 psi | n/a | n/a | 1/2" npt(m) | Brass pltd | Air |
| 207-11016-2 | 71-280 | 1/4" i.d. x 20" | 500 psi | Nylon | KF04-04RV x KF04-04PS | 1/4" nps(f) x 1/4" npt(m) | Brass pltd | Air/fluid |
| 207-11016-4 | 71-280 | 1/4" i.d. x 12" | 500 psi | Nylon | KF04-04RV x KF04-04PS | 1/4" nps(f) x 1/4" npt(m) | Brass pltd | Air/fluid |

1/4" I.D. Fluid Hose Assemblies (High Pressure Airless, Wireless)

| Part Number | Bulk Hose No. | Size | Max. Working Pressure | Tube Material | Connection Part No. | Threads | Connection Material |
|--------------|---------------|--------------------|-----------------------|---------------|---------------------|-----------------------|---------------------|
| 207-10769-1 | n/a | 1/4" i.d. x 5 ft. | 3000 psi | Nylon | Permanent | 9/16" - 18 J.I.C. sw. | n/a |
| 207-10769-11 | n/a | 1/4" i.d. x 9 1/2" | 3000 psi | Nylon | Permanent | 9/16" - 18 J.I.C. sw. | n/a |
| 207-10769-5 | n/a | 1/4" i.d. x 35 ft. | 3000 psi | Nylon | Permanent | 9/16" - 18 J.I.C. sw. | n/a |
| 207-12120-2 | n/a | 1/4" i.d. x 30" | 3000 psi | Nylon | Permanent | 1/4" nps(f) | n/a |
| 207-12120-3 | n/a | 1/4" i.d. x 17" | 3000 psi | Nylon | Permanent | 1/4" nps(f) | n/a |

E.V.A. = Ethylene Vinyl Acetate E.P.D.M. = Ethylene Propylene Diene Rubber s.s. = Stainless steel
 Steel pltd = Steel plated Brass pltd = Brass plated n/a = Not available

Hose, Connections & Assemblies

Catalyst Hose Assemblies (FRP)

Recommended Use

For acid and peroxidized catalyst and other aqueous (water) solutions. Also recommended for use as a light weight, low pressure air hose. May be used for buffing compounds and concrete resurfacing materials.

Tube

EVA

Reinforcement

Single open braid, reyon/nylon

Cover

EVA – blue

Connections

Reuseable, stainless steel tailpiece and swivel, aluminum nut.

| SIZES AVAILABLE | | BULK HOSE NO. | MAXIMUM WORKING PRESSURE (psi) | NO. OF BRAIDS | APPROX. SHIPPING WEIGHT BASED ON FEET PER REEL | HOSE WEIGHT PER 100 FEET | CONNECTION | |
|-----------------|-------|---------------|--------------------------------|---------------|--|--------------------------|--------------------------|--------------------------------------|
| i.d. | o.d. | | | | | | THREAD | PART NO. |
| 1/8 | 5/16 | 71-201 | 100 | 1 | 16 | 3.2 | 1/4"nps(f) | 102-3031 SS316 ● |
| 5/16 | 17/32 | 71-508 | 250 | 1 | 33.5 | 6.7 | 1/4"nps(f) 3/8"nps(f) | 72-1646 SS416 ● 207-10383 SS416 ● |
| 3/8 | 19/32 | 71-509 | 250 | 1 | 37.5 | 7.5 | 3/8"nps(f) | 102-3040 s.s. 316 |

● These assemblies have connections with spring guards

Catalyst Hose Assemblies (Low Pressure)

| Part Number | Bulk Hose No. | Size | Max. Working Pressure | Tube Material | Connection Part No. | Threads | Connection Material |
|-------------|---------------|-----------------------------------|-----------------------|---------------|----------------------|----------------|---------------------|
| 207-12347 | 71-223 | 1/4" i.d. x 3/8" o.d. x 8" | 100 psi | Polyethylene | 237-901 | 1/4"npt(m) | Polypropylene |
| 102-3028 | 71-201 | 1/8" i.d. x 5/16" o.d. x 25 ft. | 100 psi | E.V.A. | 102-3031 | 1/4"nps(f) sw. | 316 s.s. |
| 102-3029 | 71-201 | 1/8" i.d. x 5/16" o.d. x 35 ft. | 100 psi | E.V.A. | 102-3031 | 1/4"nps(f) sw. | 316 s.s. |
| 102-3030 | 71-201 | 1/8" i.d. x 5/16" o.d. x 50 ft. | 100 psi | E.V.A. | 102-3031 | 1/4"nps(f) sw. | 316 s.s. |
| 102-3028 | 71-201 | 1/8" i.d. x 5/16" o.d. x 25 ft. | 100 psi | E.V.A. | 102-3031 | 1/4"nps(f) sw. | 316 s.s. |
| 102-3029 | 71-201 | 1/8" i.d. x 5/16" o.d. x 35 ft. | 100 psi | E.V.A. | 102-3031 | 1/4"nps(f) sw. | 316 s.s. |
| 102-3030 | 71-201 | 1/8" i.d. x 5/16" o.d. x 50 ft. | 100 psi | E.V.A. | 102-3031 | 1/4"nps(f) sw. | 316 s.s. |
| 102-3034 | 71-201 | 1/8" i.d. x 5/16" o.d. x 30" | 100 psi | E.V.A. | n/a | 1/4"nps(f) sw. | 316 s.s. |
| 102-3036 | 71-201 | 1/8" i.d. x 5/16" o.d. x 3 ft. | 100 psi | E.V.A. | n/a | 1/4"nps(f) sw. | 316 s.s. |
| 102-3035 | 71-509 | 3/8" i.d. x 19/32" o.d. x 3 ft. | 250 psi | E.V.A. | 72-1367, 102-3033 | 3/8"nps(f) sw. | 316 s.s. |
| 71-2732 | 71-508 | 5/16" i.d. x 33/64" o.d. x 15 ft. | 250 psi | E.V.A. | 72-1646 | 1/4"nps(f) sw. | 416 s.s. |
| 71-2734 | 71-508 | 5/16" i.d. x 33/64" o.d. x 25 ft. | 250 psi | E.V.A. | 72-1646 | 1/4"nps(f) sw. | 416 s.s. |
| 71-2735 | 71-508 | 5/16" i.d. x 33/64" o.d. x 50 ft. | 250 psi | E.V.A. | 72-1646 | 1/4"nps(f) sw. | 416 s.s. |

E.V.A. = Ethylene Vinyl Acetate E.P.D.M. = Ethylene Propylene Diene Rubber s.s. = Stainless steel
 Steel pltd = Steel plated Brass pltd = Brass plated n/a = Not available

Hose, Connections & Assemblies

Catalyst Hose Assemblies (FRP)

3/16" I.D. Fluid Hose Assemblies (High Pressure Catalyst)

| Part Number | Bulk Hose No. | Size | Max. Working Pressure | Tube Material | Connection Part No. | Threads | Connection Material |
|-------------|---------------|----------------------------------|-----------------------|----------------------|---------------------|-------------------------------|---------------------|
| 107-1465 | n/a | 3/16" i.d. x 3/8" o.d. x 50 ft. | 2500 psi | Teflon/ s.s. braided | Permanent | 7/16" - 20 (f) sw. J.I.C. #4 | Steel pltd |
| 207-12305-1 | n/a | 3/16" i.d. x 5/16" o.d. x 20" | 3000 psi | Teflon/ s.s. braided | Permanent | 7/16"-20 J.I.C. sw. J.I.C. #4 | s.s. |
| 207-12305-3 | n/a | 3/16" i.d. x 5/16" o.d. x 38" | 3000 psi | Teflon/ s.s. braided | Permanent | 7/16"-20 J.I.C. sw. J.I.C. #4 | s.s. |
| 207-12305-4 | n/a | 3/16" i.d. x 5/16" o.d. x 25 ft. | 3000 psi | Teflon/ s.s. braided | Permanent | 7/16"-20 J.I.C. sw. J.I.C. #4 | s.s. |
| 207-12305-5 | n/a | 3/16" i.d. x 5/16" o.d. x 45 ft. | 3000 psi | Teflon/ s.s. braided | Permanent | 7/16"-20 J.I.C. sw. J.I.C. #4 | s.s. |
| 207-12305-7 | n/a | 3/16" i.d. x 5/16" o.d. x 35 ft. | 3000 psi | Teflon/ s.s. braided | Permanent | 7/16"-20 J.I.C. sw. J.I.C. #4 | s.s. |
| 207-12305-8 | n/a | 3/16" i.d. x 5/16" o.d. x 1 ft. | 3000 psi | Teflon/ s.s. braided | Permanent | 7/16"-20 J.I.C. sw. J.I.C. #4 | s.s. |
| 207-12305-9 | n/a | 3/16" i.d. x 5/16" o.d. x 17" | 3000 psi | Teflon/ s.s. braided | Permanent | 7/16"-20 J.I.C. sw. J.I.C. #4 | s.s. |

Fittings

| | |
|---------------------------------------|-------------|
| ADAPTERS | 6-2 |
| SWIVEL CONNECTIONS | 6-2 |
| SWIVEL ADAPTERS | 6-3 |
| SWIVEL UNIONS | 6-3 |
| REDUCING BUSHINGS | 6-4 |
| NIPPLES & REDUCING NIPPLES | 6-4 |
| ELBOWS | 6-7 |
| MISC. CONNECTIONS | 6-8 |
| TEES & CROSSES | 6-8 |
| PIPE PLUGS | 6-9 |
| QUICK DISCONNECTS | 6-10 |
| GUN / OUTLET MANIFOLDS | 6-12 |

Fittings

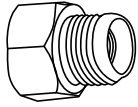

72-54, P-H-4105

Adapters

| Part Number | Description | Materials | Max. Working Pressure | Inlet | Outlet |
|----------------------|-------------|------------|-----------------------|-------------|-------------|
| LOW PRESSURE | | | | | |
| 72-54 | Adapter | Brass pltd | 250 psi | 1/4" nps(f) | 3/8" nps(m) |
| P-H-4105 | Adapter | Brass pltd | 250 psi | 1/4" nps(f) | 3/8" nps(m) |
| 73-131 | Adapter | Brass pltd | 250 psi | 1/4" nps(m) | 1/4" nps(f) |
| 72-55 | Adapter | Brass pltd | 250 psi | 1/4" nps(m) | 3/8" nps(f) |
| 73-130 | Adapter | Brass pltd | 250 psi | 3/8" nps(m) | 3/8" nps(f) |
| 0115-010235 | Adapter | s.s. | 250 psi | 3/4" nps(m) | 1/2" nps(f) |
| HIGH PRESSURE | | | | | |
| 207-10699 | Adapter | 303 s.s. | 3500 psi | 1/4" nps(m) | 1/4" npt(f) |
| 72-727 | Adapter | 303 s.s. | 4000 psi | 1/8" npt(f) | 1/4" nps(m) |
| 72-731 | Adapter | Steel pltd | 5000 psi | 3/8" npt(f) | 1/4" nps(m) |



73-18

Swivel Connections (90°)

| Part Number | Description | Materials | Max. Working Pressure | Inlet | Outlet |
|----------------------|--|------------|-----------------------|----------------|-----------------|
| LOW PRESSURE | | | | | |
| SSP-30-ZN | 90° swivel | Steel pltd | 250 psi | 1/4" npt(m) | 1/4" nps(f) |
| 72-989 | Swivel ass'y 90 deg. 5, 10 & 15 Gal tanks, single tank outlet | Steel | 250 psi | 3/8" npt(f) | 7/8-18 (f) |
| 73-16 | Swivel connection | Brass | 250 psi | 3/8" nps(f) | 3/8" nps(m) |
| 73-18 | Elbow swivel 90 deg. | Brass pltd | 250 psi | 1/4" nps(m) | 3/8" nps(f) |
| HIGH PRESSURE | | | | | |
| 72-918 | Connection 90 deg. | Steel | 4000 psi | 1/4" npt(f) | 1/4" nps(f) |
| 103-1238 | Swivel connection | 316 s.s. | 4000 psi | 1/4" npt(m) | 3/8" nps(f) |
| 73-24 | Elbow swivel 90 deg. | 303 s.s. | 3000 psi | 3/8" nps(m) | 3/8" nps(f) |
| SSP-57-ZN | 90° Swivel connection | Steel pltd | 4000 psi | 3/8" npt(m) | 3/8" nps(f) |
| DOUBLE OUTLET | | | | | |
| 72-994 | Double tank outlet, 60 gal tank | Brass pltd | 200 psi | 7/8-18" nps(f) | (2) 3/8" npt(f) |

N/R = Non-Rated • Pltd brass = Plated brass, chrome • S.S. = Stainless steel
Galv. = Galvanized steel • Steel pltd = Plated steel, cadmium or zinc • Poly = Polypropylene plastic

Fittings

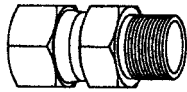

SSP-8217-ZN

Swivel Adapters (Straight)

| Part Number | Description | Materials | Max. Working Pressure | Inlet | Outlet |
|--------------|----------------|------------|-----------------------|-------------|-------------|
| SSP-8217-ZN | Swivel adapter | Steel pltd | 4000 psi | 1/4" nps(f) | 1/4" npt(m) |
| 103-1238 | Swivel adapter | s.s. | 4000 psi | 1/4" npt(m) | 3/8" nps(f) |
| 20-4281 | Swivel adapter | Steel pltd | 4000 psi | 3/8" npt(m) | 3/8" nps(f) |
| 20-4284 | Swivel adapter | Steel pltd | 3000 psi | 3/4" npt(m) | 3/4" nps(f) |
| 20-4283 | Swivel adapter | Steel pltd | 3500 psi | 1/2" npt(m) | 1/2" nps(f) |
| PLH-6SN-6TSS | Swivel adapter | s.s. | 250 psi | 3/8" nps(m) | 3/8" nps(f) |

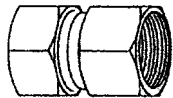

83-1935, 102-2126

Swivel Unions

| Part Number | Description | Materials | Max. Working Pressure | Inlet | Outlet |
|-------------|--------------|------------|-----------------------|-------------|-------------|
| 72-1253 | Swivel union | Steel pltd | 4000 psi | 3/8" npt(f) | 1/4" nps(f) |
| 83-1935 | Swivel union | Steel pltd | 4000 psi | 1/4" npt(f) | 1/4" nps(f) |
| 102-2126 | Swivel union | 303 s.s. | 3000 psi | 1/4" npt(f) | 1/4" nps(f) |

N/R = Non-Rated • Pltd brass = Plated brass, chrome • S.S. = Stainless steel
Galv. = Galvanized steel • Steel pltd = Plated steel, cadmium or zinc • Poly = Polypropylene plastic

Fittings

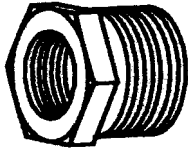

20-3809-1

Reducing Bushings

| Part Number | Description | Materials | Max. Working Pressure | Inlet | Outlet |
|----------------------|-------------|------------|-----------------------|---------------|-------------|
| LOW PRESSURE | | | | | |
| 20-2525 | Bushing | Galv. | 250 psi | 3/4" npt(m) | 1/2" npt(f) |
| HIGH PRESSURE | | | | | |
| 20-3809-1 | Bushing | Steel pltd | 4000 psi | 1/2" npt(m) | 1/4" npt(f) |
| 20-3815 | Bushing | 304 s.s. | 3000 psi | 1/2" npt(m) | 3/8" npt(f) |
| 20-3823-1 | Bushing | Steel pltd | 3000 psi | 1/2" npt(m) | 3/8" npt(f) |
| 20-4924 | Bushing | Steel pltd | 3000 psi | 1-1/4" npt(m) | 1" npt(f) |
| 237-614 | Bushing | Steel | 4000 psi | 3/4" npt(f) | 1" npt(m) |
| 20-4347 | Bushing | Steel pltd | 3000 psi | 3/4" npt(m) | 3/8" npt(f) |
| 20-1753-1 | Bushing | Steel pltd | 4000 psi | 3/8" npt(m) | 1/4" npt(f) |
| 20-3083 | Bushing | 316 s.s. | 4000 psi | 3/8" npt(m) | 1/4" npt(f) |

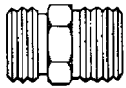

H-2008

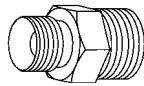

AD-26

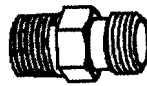

83-576

Nipples & Reducing Nipples

| Part Number | Description | Materials | Max. Working Pressure | Inlet | Outlet |
|---------------------|-----------------|------------|-----------------------|-------------|---------------------|
| LOW PRESSURE | | | | | |
| 54-308 | Reducing nipple | Brass pltd | 250 psi | 1/8" nps(m) | 1/4" nps(m) |
| 71-28 | Reducing nipple | Brass pltd | 750 psi | 1/8" npt(m) | 1/4" nps(m) |
| H-2008 | Nipple | Brass pltd | 750 psi | 1/4" nps(m) | 1/4" npt(m) |
| 83-1050 | D.M. Nipple | Brass | 750 psi | 1/4" nps(m) | 1/4" nps(m) |
| AD-31 | D.M. Nipple | Brass pltd | 750 psi | 1/4" nps(m) | 1/4" nps(m) |
| AD-26 | Reducing nipple | Brass pltd | 750 psi | 1/4" nps(m) | 3/8" nps(m) |
| SSP-462-ZN | D.M. Nipple | Steel pltd | 750 psi | 1/4" npt(m) | 1/4" npt(m) |
| 57-13-1 | D.M. Nipple | Brass pltd | 750 psi | 1/4" npt(m) | 1/4" nps(m)/bspp(m) |
| 83-576 | D.M. Nipple | Brass | 750 psi | 1/4" npt(m) | 1/4" nps(m) |
| H-209 | D.M. Nipple | Brass pltd | 750 psi | 1/4" npt(m) | 9/16-20 (m) |

N/R = Non-Rated • Pltd brass = Plated brass, chrome • S.S. = Stainless steel
Galv. = Galvanized steel • Steel pltd = Plated steel, cadmium or zinc • Poly = Polypropylene plastic

Fittings

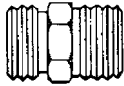

H-2008

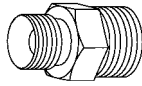

AD-26

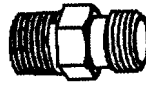

83-576

Nipples & Reducing Nipples

| Part Number | Description | Materials | Max. Working Pressure | Inlet | Outlet |
|---------------------------------|-----------------|------------|-----------------------|---------------|-----------------------|
| LOW PRESSURE (continued) | | | | | |
| 83-1294 | D.M. Nipple | Brass pltd | 750 psi | 3/8" nps(m) | 3/8" nps(m) |
| PLH-6-6TSS | Nipple | S.S. | 250 psi | 3/8" npt(m) | 3/8" nps(m) |
| AD-11 | D.M. Nipple | Brass pltd | 750 psi | 3/8" npt(m) | 3/8" nps(m) |
| 73-50 | D.M. Nipple | Brass pltd | 750 psi | 3/8" npt(m) | 3/8" nps(m) |
| 83-1185 | D.M. Nipple | Brass pltd | 750 psi | 3/8" npt(m) | 3/8" npt(m) |
| 83-1823 | D.M. Nipple | Brass | 500 psi | 1/2" npt(m) | 1/2" nps(m) |
| 72-1243 | D.M. Nipple | Brass pltd | 500 psi | 1/2" npt(m) | 1/2" nps(m) |
| 83-1822 | D.M. Nipple | Brass pltd | 750 psi | 3/4" nps(m) | 3/4" nps(m) |
| 72-423 | D.M. Nipple | Brass pltd | 500 psi | 1" npt(m) | 1" nps(m) |
| HIGH PRESSURE | | | | | |
| 237-859 | D.M. Nipple | 316 s.s. | 6000 psi | #3 J.I.C. (m) | #3 J.I.C. (m) |
| 107-1635 | D.M. Nipple | 316 s.s. | 6000 psi | #3 J.I.C. (m) | 1/8" npt(m) |
| 237-871 | D.M. Nipple | 316 s.s. | 5000 psi | #4 J.I.C. (m) | #4 J.I.C. (m) |
| 107-1439 | D.M. Nipple | 316 s.s. | 5000 psi | #4 J.I.C. (m) | 1/4" npt(m) |
| 107-1449 | Reducing nipple | s.s. | 5000 psi | #4 J.I.C. (m) | 1/8" npt(m) |
| 207-12349 | Reducing nipple | 303 s.s. | 4000 psi | #4 J.I.C. (m) | 3/8-24 unf (m) |
| 72-792 | Reducing nipple | 303 s.s. | 5000 psi | 1/8" npt(m) | 1/4" nps(m) |
| 72-969 | Reducing nipple | 303 s.s. | 3000 psi | 1/8" npt(m) | 3/8" nps(m) |
| HGS-22 | Reducing nipple | s.s. | 3000 psi | 1/8" npt(m) | 1/4" nps(m) |
| HGS-21 | Reducing nipple | s.s. | 3000 psi | 1/8" npt(m) | 3/8" nps(m) |
| 72-1268 | Reducing nipple | Steel pltd | 5000 psi | 1/4" npt(m) | 3/8" npt(m) |
| 72-790 | D.M. Nipple | 316 s.s. | 4500 psi | 1/4" npt(m) | 1/4" nps(m) |
| 72-690 | D.M. Nipple | Steel pltd | 6000 psi | 1/4" npt(m) | 1/4" nps(m) |
| 20-4854 | D.M. Nipple | 316 s.s. | 6000 psi | 1/4" npt(m) | 1/4" npt(m) |
| 83-2484 | Reducing nipple | 303 s.s. | 3000 psi | 1/4" npt(m) | 3/8" nps(m) |
| 237-375 | Nipple | Steel pltd | 6000 psi | 1/4" npt(m) | 1/4" npt(m) |
| 83-4233 | Reducing nipple | Steel pltd | 6000 psi | 1/4" npt(m) | 3/8" npt(m) |
| H-1580-H | Reducing nipple | s.s. | 3000 psi | 1/4" npt(m) | 3/8" nps(m) / bsp (m) |
| 72-791 | D.M. Nipple | 303 s.s. | 4500 psi | 1/4" nps(m) | 1/4" nps(m) |
| 72-691 | D.M. Nipple | Steel pltd | 6000 psi | 1/4" nps(m) | 1/4" nps(m) |

N/R = Non-Rated • Pltd brass = Plated brass, chrome • S.S. = Stainless steel
Galv. = Galvanized steel • Steel pltd = Plated steel, cadmium or zinc • Poly = Polypropylene plastic

Fittings

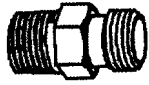

72-1888

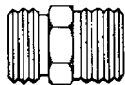

83-2055

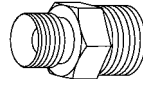

72-1316



873188

Nipples & Reducing Nipples

| Part Number | Description | Materials | Max. Working Pressure | Inlet | Outlet |
|----------------------------------|-----------------|--------------------|-----------------------|----------------------|----------------------|
| HIGH PRESSURE (continued) | | | | | |
| 101-1772 | Reducing nipple | 316 s.s. | 5000 psi | 1/4" nps(m) | 1/8" npt(m) |
| 72-1888 | Reducing nipple | Steel pltd | 6000 psi | 1/4" nps(m) | 3/8" nps(m) |
| 72-988 | Reducing nipple | 303 s.s. | 4500 psi | 1/4" nps(m) | 3/8" npt(m) |
| 72-798 | D.M. Nipple | 303 s.s. | 4500 psi | 3/8" nps(m) | 3/8" nps(m) |
| 72-1933 | Reducing nipple | 303 s.s. | 5000 psi | 3/8" npt(m) | 1/2" nps(m) |
| 83-2055 | D.M. Nipple | 303 s.s. | 4500 psi | 3/8" npt(m) | 3/8" nps(m) |
| 72-998 | D.M. Nipple | Steel pltd | 3000 psi | 3/8" npt(m) | 3/8" npt(m) |
| SSP-459 | D.M. Nipple | 316 s.s. | 6000 psi | 3/8" npt(m) | 3/8" npt(m) |
| 237-266 | D.M. Nipple | Steel | 6000 psi | 1/2" npt(m) | 1/2" npt(m) |
| 237-374 | Reducing nipple | Steel | 6000 psi | 1/2" npt(m) / nps(m) | 3/8" npt(m) / nps(m) |
| 72-1316 | Reducing nipple | Steel pltd | 4000 psi | 1/2" npt(m) | 3/4" npt(m) |
| 41-1235 | D.M. Nipple | 303 s.s. | 2500 psi | 1/2" nps(m) | 1/2" npt(m) |
| 72-1770 | D.M. Nipple | 303 s.s. | 2000 psi | 3/4" npt(m) | 3/4" nps(m) |
| 72-1102 | D.M. Nipple | Steel pltd | 4000 psi | 3/4" npt(m) | 3/4" npt(m) |
| 101-713 | D.M. Nipple | Steel, 3 1/2" long | 5000 psi | 3/4" npt(m) | 3/4" nps(m) |
| 41-28090 | Reducing nipple | Steel pltd | 6000 psi | 3/4" npt(m) | 1/2" npt(m) |
| 72-1374 | D.M. Nipple | Steel pltd | 3500 psi | 1" npt(m) | 1" npt(m) |
| 72-1981 | D.M. Nipple | Steel pltd | 3500 psi | 1" npt(m) | 1" nps(m) |
| 873188 | Reducing nipple | Steel pltd | 6000 psi | 1" npt(m) | 1/2" npt(m) |

N/R = Non-Rated • Pltd brass = Plated brass, chrome • S.S. = Stainless steel
Galv. = Galvanized steel • Steel pltd = Plated steel, cadmium or zinc • Poly = Polypropylene plastic

Fittings

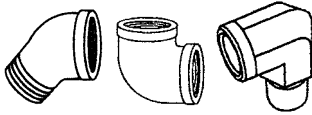

Elbows

| Part Number | Description | Materials | Max. Working Pressure | Inlet | Outlet |
|----------------------|------------------------|------------|-----------------------|---------------|-----------------|
| LOW PRESSURE | | | | | |
| 20-6 | Elbow 90 deg. | Blk. Iron | 150 psi | 1" npt(f) | 1" npt(f) |
| 20-99 | Elbow street 90 deg. | Blk. Iron | 150 psi | 1" npt(f) | 1" npt(m) |
| 20-3340-1 | Elbow street 90 deg. | Brass pltd | 250 psi | 1/2" npt(m) | 1/2" npt(f) |
| 237-250 | Elbow 90 deg. | Brass | 150 psi | 1/4" npt(m) | 1/4" tube |
| 237-902 | Elbow 90 deg. | Poly | 150 psi | 1/4" npt(m) | 3/8" tube |
| 86-563 | Elbow street 90 deg. | Brass pltd | 250 psi | 1/4" npt(m) | 1/4" npt(f) |
| 207-11918 | Elbow, inlet | Poly | 150 psi | 1/8" npt(m) | 1/4" o.d. tube |
| 237-528 | Elbow 90 deg. | Poly | 150 psi | 1/8" npt(m) | 1/4" o.d. tube |
| 20-3645 | Elbow street 90 deg. | Brass pltd | 250 psi | 1/8" npt(m) | 1/8" npt(f) |
| 237-572 | Elbow 45 deg. | Brass | 250 psi | 1/8" npt(m) | #5 J.I.C. (m) |
| 237-247 | Elbow 90 deg. | Brass | 250 psi | 1/8" npt(m) | 1/4" hose |
| HIGH PRESSURE | | | | | |
| 237-743 | Elbow 90 deg. | s.s. | 3000 psi | 1" npt(m) | 1" o.d. tube |
| 20-3590 | Elbow street 90 deg. | s.s. | 3000 psi | 3/4" npt(m) | 3/4" npt(f) |
| 237-276 | Reducing elbow 90 deg. | Steel pltd | 6000 psi | 1/2" npt(f) | #6 J.I.C. (m) |
| 20-3821 | Elbow street 90 deg. | Steel pltd | 3000 psi | 3/8" npt(m) | 3/8" npt(f) |
| 20-2848 | Elbow 90 deg. | 304 s.s. | 4000 psi | 1/4" npt(f) | 1/4" npt(f) |
| 107-1636 | Elbow 90 deg. | 316 s.s. | 8000 psi | 1/4" npt(m) | 1/4" o.d. tube |
| 101-1770 | Elbow street 90 deg. | 316 s.s. | 7200 psi | 1/4" npt(m) | 1/4" npt(f) |
| 237-263 | Elbow street 90 deg. | Steel pltd | 5000 psi | 1/4" npt(m) | 1/4" npt(f) |
| 107-1646 | Elbow 90 deg. | 316 s.s. | 5000 psi | 1/8" npt(m) | #4 J.I.C. (m) |
| 237-767 | Elbow street 45 deg. | Steel | 5000 psi | 1/4" npt(m) | 1/4" npt(f) |
| 207-12085 | Reducing elbow 90 deg. | s.s. | 6000 psi | #4 J.I.C. (m) | 1/2" nps(f) sw. |
| 237-295 | Reducing elbow 90 deg. | Steel pltd | 3000 psi | #12 J.I.C. | 3/4" npt(f) |
| SSP-1941-ZN | Street elbow 90 deg. | Steel pltd | 5000 psi | 1/4" npt(m) | 1/4" npt(f) |

N/R = Non-Rated • Pltd brass = Plated brass, chrome • S.S. = Stainless steel
Galv. = Galvanized steel • Steel pltd = Plated steel, cadmium or zinc • Poly = Polypropylene plastic

Fittings

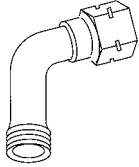

P-H-431, P-H-432

Misc. Connections

| Part Number | Description | Materials | Max. Working Pressure | Inlet | Outlet |
|---------------------|-------------------------|------------|-----------------------|-------------------|----------------|
| LOW PRESSURE | | | | | |
| P-H-432 | Fitting | n/a | 750 psi | 3/8" nps(f) sw | 3/8" nps(m) |
| P-H-431 | Fitting | n/a | 750 psi | 1/4" nps(f) sw | 1/4" nps(m) |
| 237-901 | Connection | Poly | 150 psi | 1/4" npt(m) | 3/8 tube |
| 85-85 | Air tube connection | Brass pltd | 250 psi | 1/8" npt(m) | 3/8-24 unf (f) |
| SSP-6102-K5 | Fitting, 90 deg. Barbed | Brass | 250 psi | 1/8" npt(m) | .170 i.d. tube |
| 4358 | Fitting | n/a | 750 psi | #12 J.I.C. (f) sw | 3/4 i.d. hose |

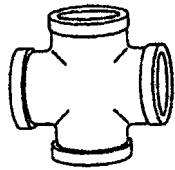

20-4593

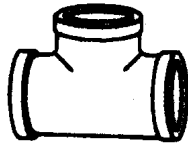

101-2050

Tees & Crosses

| Part Number | Description | Type | Max. Working Pressure | Inlet | Outlet |
|-------------|--------------|------------|-----------------------|-----------------------|-----------------------|
| 20-4593 | Cross | Steel | 3000 psi | 1/2" npt(f) all ports | 1/2" npt(f) all ports |
| 237-280 | male run tee | Steel pltd | 3000 psi | 1/2" npt(m) | (2) 1/2" npt(f) |
| 101-2050 | Tee | 316 s.s. | 3000 psi | 1/4" npt(f) all ports | 1/4" npt(f) all ports |
| 237-914 | Street tee | 316 s.s. | 3000 psi | 1/4" npt(m) | (2) 1/4" npt(f) |
| SSP-2629-ZN | Branch tee | Steel pltd | 5000 psi | 1/4" npt(m) | (2) 1/4" npt(f) |

N/R = Non-Rated • Pltd brass = Plated brass, chrome • S.S. = Stainless steel
Galv. = Galvanized steel • Steel pltd = Plated steel, cadmium or zinc • Poly = Polypropylene plastic

Fittings



HEX



SQUARE HEAD

Pipe Plugs – Internal Hex & Square Head

| Part Number | Description | Materials | Max. Working Pressure | Inlet | Type |
|----------------------|-------------|------------------|-----------------------|--------------|-------------|
| HIGH PRESSURE | | | | | |
| 20-5692 | Pipe plug | Steel pltd | 4000 psi | 1/16" npt(m) | Hex |
| 20-5051 | Pipe plug | s.s. | 4000 psi | 1/16" npt(m) | Hex |
| 20-3111 | Pipe plug | 303 s.s. | 4000 psi | 1/8" npt(m) | Hex |
| 20-2287-1 | Pipe plug | Steel pltd | 4000 psi | 1/8" npt(m) | Hex |
| 20-6131 | Pipe plug | s.s. | 4000 psi | 1/4" npt(m) | Hex |
| 20-2288-1 | Pipe plug | Steel pltd | 4000 psi | 1/4" npt(m) | Hex |
| 20-4401 | Pipe plug | 303 s.s. | 4000 psi | 1/4" npt(m) | Square head |
| 20-6739 | Pipe plug | s.s. | 4000 psi | 1/4" npt(m) | Hex |
| 86-558 | Pipe plug | Steel pltd | 4000 psi | 1/4" npt(m) | Square head |
| 237-338 | Pipe plug | Steel pltd | 4000 psi | 1/4" npt(m) | Hex |
| 237-774 | Pipe plug | s.s. | 4000 psi | 1/4" npt(m) | Hex |
| 20-1592 | Pipe plug | Steel pltd | 4000 psi | 3/8" npt(m) | Square head |
| 20-2097 | Pipe plug | Steel | 4000 psi | 1/2" npt(m) | Hex |
| NON-RATED | | | | | |
| 237-336 | Pipe plug | Steel | n/r | 1/16" npt(m) | Hex |
| 237-879 | Pipe plug | Steel | n/r | 2" npt(m) | Bung |
| 20-2605-1 | Pipe plug | Steel | n/r | 3/8" npt(m) | Hex |
| SSP-1421 | Pipe plug | — | — | 3/8" npt(m) | Hex |
| SSP-1441-ZN | Pipe plug | Steel, zinc pltd | 300 psi | 3/8" npt(m) | Hex |

N/R = Non-Rated • Pltd brass = Plated brass, chrome • S.S. = Stainless steel
Galv. = Galvanized steel • Steel pltd = Plated steel, cadmium or zinc • Poly = Polypropylene plastic

Fittings



P-HC-4808-1

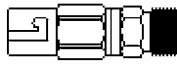

72-1804

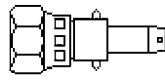

72-364

Quick Disconnects – Bayonett Style (Fluid)

Binks Style

| Part Number | Type | Description | Max. Working Pressure | Connection | Service Form |
|-------------|----------|-----------------|-----------------------|-------------|--------------|
| 72-1804 | Body (f) | Stainless steel | 500 psi | 3/8" nps(m) | n/a |
| 72-364 | Stem (m) | Stainless steel | 500 psi | 3/8" nps(f) | n/a |

DeVilbiss Style

| | | | | | |
|-------------|----------|------------------|---------|--------------------|-----------|
| P-HC-4808-1 | Body (f) | Aluminum | 500 psi | 3/8" nps(m) | SB-12-001 |
| P-HC-4482 | Stem (m) | Hardened Steel | 500 psi | 3/8" nps(f) | SB-12-001 |
| HC-513-1 | Body (f) | Stainless steel | 500 psi | 3/8" nps(m) | SB-12-001 |
| QDL-4808 | Body (f) | Delrin/Stainless | 500 psi | 3/8" nps(m) | SB-12-001 |
| HC-4691 | Stem (m) | Stainless steel | 500 psi | 3/8" nps(f) swivel | SB-12-001 |



72-885 w/72-887 stem connected

Binks Quick Disconnects (Fluid – Solvent Based)

| Part Number | Type | Description | Max. Working Pressure | Connection Size | Service Form |
|-------------|----------|-------------|-----------------------|-----------------|--------------|
| 72-885 | Body (f) | Steel | 250 psi | 3/8" nps(m) | n/a |
| 72-887* | Stem (m) | Steel | 250 psi | 3/8" nps(f) | n/a |

*Replacement o-ring for stem: 20-3620-5 (5-pack Viton)

Binks Quick Disconnect Assemblies (Fluid – Solvent Based)

| Part Number | Description | Max. Working Pressure | Service Form |
|-------------|--------------------------|-----------------------|--------------|
| 72-888 | 72-885 Body 72-887 Stem* | 250 psi | n/a |

**Replacement o-ring for stem: 20-3620-5 (5-pack Viton)



72-780

Binks High Pressure Swivel Connection (Fluid – Solvent Based)

| Part Number | Description | Materials | Max. Working Pressure | Inlet | Outlet |
|-------------|-------------------|-----------|-----------------------|-------------|-------------|
| 72-780 | Swivel connection | Steel | 3000 psi | 1/4" nps(m) | 1/4" nps(f) |
| 72-2332 | Swivel connection | Steel | 7500 psi | 1/4" nps(m) | 1/4" nps(f) |
| 72-2333 | Swivel connection | Steel | 7500 psi | 3/8" nps(m) | 1/4" nps(f) |

N/R = Non-Rated • Pltd brass = Plated brass, chrome • S.S. = Stainless steel
Galv. = Galvanized steel • Steel pltd = Plated steel, cadmium or zinc • Poly = Polypropylene plastic

Fittings



237-358



237-359

Binks Quick Disconnect Assemblies (High Pressure Fluid)

| Part Number | Type | Description | Connection Size | Max. Working Pressure | Service Form |
|-------------|----------|-------------|-----------------|-----------------------|--------------|
| 237-358* | Body (f) | Steel pltd | 1/4"npt(f) | 3700 psi max | n/a |
| 237-359 | Stem (m) | Steel pltd | 1/4"npt(f) | 3700 psi max | n/a |

*Replacement o-ring 20-6037-K10, Teflon; or 237-72 EPR



72-2063



72-2066



72-2073



72-445



72-467

Binks Quick Disconnects (Air)

| Part Number | Type | Description | Connection Size | Max. Working Pressure | Service Form |
|-------------|----------|-------------|-----------------|-----------------------|--------------|
| 72-2063 | Body (f) | Standard | 1/4"nps(m) | 200 psi | n/a |
| 72-2066 | Body (f) | Standard | 5/16 i.d. hose | 200 psi | n/a |
| 72-2073 | Body (f) | Standard | 1/4"npt(f) | 200 psi | n/a |
| 72-445 | Stem (m) | Standard | 1/4"nps(f) | 200 psi | n/a |
| 72-467 | Stem (m) | Standard | 1/4"npt(m) | 200 psi | n/a |

Binks Quick Disconnect Assemblies (Air)

| Obsolete Part Number | Order: Description | Max. Working Pressure | Service Form |
|----------------------|---|-----------------------|--------------|
| 72-2076 | (body and stem shown in above chart) 72-2063 Body 72-445 Stem | 200 psi | n/a |
| 72-470 | (body and stem shown in above chart) 72-2063 Body 72-467 Stem | 200 psi | n/a |
| 72-474 | (body and stem shown in above chart) 72-2073 Body 72-445 Stem | 200 psi | n/a |
| 72-476 | (body and stem shown in above chart) 72-2073 Body 72-467 Stem | 200 psi | n/a |

N/R = Non-Rated • Pltd brass = Plated brass, chrome • S.S. = Stainless steel
Galv. = Galvanized steel • Steel pltd = Plated steel, cadmium or zinc • Poly = Polypropylene plastic

Fittings

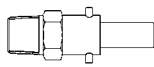

P-H-4069

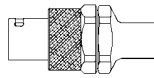

P-H-4090

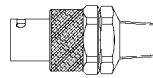

P-H-4091

DeVilbiss Quick Disconnects (Air)

| Part Number | Type | Description | Connection Size | Max. Working Pressure | Service Form |
|-------------|------|-------------|-----------------|-----------------------|--------------|
| P-H-4069 | Stem | Air bayonet | 1/4" npt(m) | 250 psi | n/a |
| P-H-4090 | Body | Air bayonet | 1/4" npt(f) | 250 psi | n/a |
| P-H-4091 | Body | Air bayonet | 1/4" npt(m) | 250 psi | n/a |

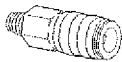

HC-4699



HC-4700

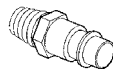

HC-1166

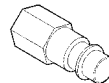

HC-4419



MPV-60-K3

DeVilbiss Quick Disconnects (High-Flow Air)

| Part Number | Type | Description | Connection Size | Max. Working Pressure | Service Form |
|-------------|----------|-----------------------|--------------------|-----------------------|--------------|
| HC-4699 | Body (f) | Hi-flow | 1/4" universal (m) | 230 psi | SB-12-001 |
| HC-4700 | Body (f) | Hi-flow | 1/4" npt(f) | 230 psi | SB-12-001 |
| HC-1166 | Stem (m) | Hi-flow | 1/4" npt(m) | 230 psi | SB-12-001 |
| HC-4419 | Stem (m) | Hi-flow | 1/4" nps(f) | 230 psi | SB-12-001 |
| MPV-60-K3 | Stem (f) | Hi-flow (ball swivel) | 1/4" nps(f) | 230 psi | n/a |

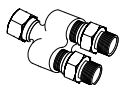

72-1823, 72-1869

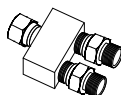

72-1927

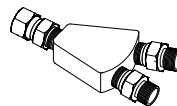

111-1354

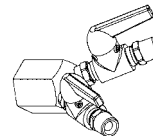

83-2155

Gun/Outlet Manifolds

| Part Number | Max. Working Pressure | No. of Outlets | Outlet Threads | Inlet Swivel Nut | Notes |
|-------------|-----------------------|----------------|----------------|------------------|---|
| 72-994 | 200 psi | 2 | 3/8" npt(f) | 7/8" -18 nps(f) | Ptld brass |
| 72-1823 | 250 psi | 2 | 3/8" nps(m) | 3/8" nps(f) | Stainless steel |
| 72-1927 | 250 psi | 2 | 1/4" nps(m) | 1/4" nps(f) | Plated brass fittings, plated steel body and swivel nut |
| 72-1869 | 1000 psi | 2 | 1/4" nps(m) | 3/8" nps(f) | Stainless steel |
| 111-1354* | 3000 psi | 2 | 1/4" nps(m) | 1/4" nps(f) | Used in circulating and heated fluid systems for fluid |
| 83-2155 | 4000 psi | 2 | 3/8" npt(m) | 1" npt(f) | 303 Stainless steel body with 4000 psi valves |

*For 2-gun air outlet for AA spray guns, remove the 2 ea. 1/8" npt(m) x 1/4" nps(m) fittings and add 2 ea. 1/8" -1/4" i.d. x 3/8" o.d. tube fittings (54-4975).

N/R = Non-Rated • Ptld brass = Plated brass, chrome • S.S. = Stainless steel
Galv. = Galvanized steel • Steel ptld = Plated steel, cadmium or zinc • Poly = Polypropylene plastic

Air Supply Controls & Gauges

| | |
|--|-------------|
| AIR REGULATORS | 7-2 |
| BYPASS AIR REGULATORS | 7-4 |
| AIR CONTROL ASSEMBLIES (PUMPS) | 7-6 |
| AIR CONTROL ASSEMBLIES (PRESSURE TANKS) | 7-7 |
| CENTRIFUGAL AIR FILTERS / REGULATORS | 7-8 |
| COALESCER UNITS | 7-10 |
| DESICCANT UNITS | 7-12 |
| 1 STAGE CHARCOAL FILTER | 7-14 |
| 3 STAGE BREATHING AIR UNIT | 7-14 |
| 2 STAGE FILTER / REGULATOR | 7-14 |
| FILTER ELEMENT KITS | 7-16 |
| AIR VIZOR™ BREATHABLE AIR SYSTEMS | 7-16 |
| AIR PRESSURE GAUGES | 7-17 |

Air Supply Controls & Gauges

HAR Air Regulators

General purpose regulators for line takeoff use or as integral regulators on pumps, pressure tanks and other air operated devices. Require separate trap or filter in air line to remove moisture or dirt.

- Removable plug and cap.
- All metal body; durable Delrin® cap, metal T handle; Buna N diaphragm and disc.
- Accurate regulator mechanism provides precision air control.
- Self-relieving design.
- Both main line and regulated outlets available from same units.

HAR-501® Air Regulator

Extra Sensitive regulator for use with precision control on pressure feed tanks or other dead-end applications. Can be used to control atomization pressure for one spray gun.

- Self-relieving regulator.
- Tough, reinforced Buna N diaphragm for extended service life.
- 100 mesh stainless steel strainer.
- Removable bottom plug for easy service.
- Forged brass body and stainless steel or brass internal parts for long service.
- High ratio of diaphragm surface to orifice area provides stable uniform regulation.

Air Regulators

| Part Number | Description | Inlet | Outlet(s) | Inlet Press. Max. | Outlet Press. Min. | Outlet Press. Max. | Where Used |
|--------------------|------------------------------------|-------------|---|-------------------|--------------------|--------------------|---|
| 107-1342 | Air regulator | 1/4" npt(f) | 2 ea 1/4" npt(f) 1 1/8" npt(f) | n/a | 0 psi | 60 psi | 103-1285 reg., 73-134 air control, 85-238 air control |
| 107-1343 | Air regulator | 3/4" npt(f) | 1 ea 3/4" npt(f) 2 ea 1/4" npt(f) | 250 psi | 5 psi | 125 psi | 101-9251 air control |
| 873465 | Air regulator | 1/4" npt(f) | 3 ea 1/4" npt(f) | n/a | 0 psi | 125 psi | Raptor – pump |
| 873466 | Air regulator | 1/4" npt(f) | 3 ea 1/4" npt(f) | n/a | 0 psi | 50 psi | Raptor – atom. air |
| 85-214 | Air regulator | 1/4" npt(f) | 3 ea 1/4" npt(f) Regulated | n/a | 0 psi | 100 psi | Old style Binks non-ASME pressure tanks |
| HAR-507 | Air regulator | 3/8" npt(f) | 3 ea 1/4" npt(f) | 150 psi | 0 psi | 125 psi | Pressure tanks |
| HAR-535 | Air regulator | 3/8" npt(f) | 1/4" npt(f) Unregulated 1/4" npt(f) Regulated 3/8" npt(f) Regulated | 250 psi | 0 psi | 125 psi | General use |
| HAR-555 | Air regulator | 3/8" npt(f) | 2 ea 1/4" npt(f) Unregulated 1 ea 1/2" npt(f) Regulated | 250 psi | 0 psi | 125 psi | General use |
| HAR-600 | Air regulator w/ gauge | 3/8" npt(f) | 3 ea 1/4" npt(f) | 150 psi | 0 psi | 125 psi | Pressure tanks and general use |
| HARG-510 | Air regulator w/ gauge | 1/4" nps(m) | 1/4" nps(f) SWIVEL | 300 psi | 5 psi | 100 psi | Gun atom. air reg. assy. |
| 237-635 | Air regulator | 1/2" npt(f) | 2 ea 1/4" npt 1 ea 1/2" npt(f) | n/a | 0 psi | 125 psi | Excel pumps – air control |
| JGHV-453 / KK-4980 | Air regulator (mini) regulator kit | 1/4" npt(f) | 1 ea 1/4" npt(f) 1 ea 1/8" npt(f) | 125 psi | 0 psi | 8 psi | TLC-576, TGC-600, TSC-591 pressure cups |
| HAR-501 | Air regulator (extra sensitive) | 3/8" npt(f) | 3/8" npt(f) | 250 psi | 0 psi | 20 psi | Pressure tanks |
| 849315 | Piggyback filter / air regulator | 1/2" npt(f) | 1/2" npt(f) | 250 psi | 5 psi | 140 psi | Infinity pumps |
| 85-441 | Air regulator | 1/4" nps(f) | 1/4" nps(f) | | 2 psi | 50 psi | 80-295, 80-296, 80-600, 80-651 |
| 85-502 | Air regulator | 3/4" npt | 3/4" npt 1/4" npt (x2) Regulated | 300 psi | 5 psi | 150 psi | BX pumps |

HAR-400 Regulator Lockout Accessory

Used with any HAR, T Handle style air regulators.

This device allows the painter to set their air regulators to guarantee proper atomization, as well as to assure compliance in areas where air cap pressure is limited to 10 psi or less. Includes one key per unit.

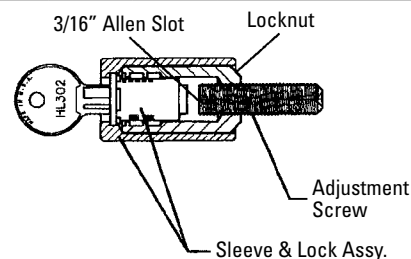

Air Supply Controls & Gauges

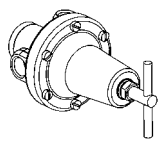

HAR-507

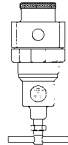

**HAR-535
HAR-555**



HARG-510

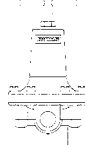

237-635

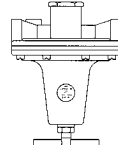

HAR-501



849315

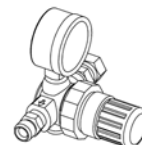

85-441

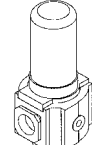

85-502

Air Regulators

| Part Number | Capacity | Type | Gauge | Repair Kit | Service Form |
|-----------------------|----------|----------|---|------------|--------------|
| 107-1342 | n/a | Knob | Optional 59-369 gauge 0-60 | n/a | n/a |
| 107-1343 | n/a | Knob | None | None | 77-2315 |
| 873465 | n/a | Knob | Optional 849306 gauge 0-160 | None | None |
| 873466 | n/a | Knob | Optional 849314 gauge 0-60 | None | None |
| 85-214 | 30 cfm | Knob | Optional 83-2727 gauge 0-100 | 6-207 | 77-1890 |
| HAR-507 | 60 cfm | T-Handle | Optional GA-288 gauge 0-160 | KK-4977 | SB-6-147 |
| HAR-535 | 40 cfm | T-Handle | Optional GA-33 gauge 0-30 or GA-333 gauge 0-100 or GA-288 gauge 0-160 | KK-4139-3 | SB-6-162 |
| HAR-555 | 40 cfm | T-Handle | None | KK-4139-3 | SB-6-162 |
| HAR-600 | 60 cfm | T-Handle | Includes GA-288 gauge 0-160 | KK-4977 | SB-6-147 |
| HARG-510 | n/a | Knob | Includes GA-338 gauge 0-160 | KB-428-1 | SB-6-105 |
| 237-635 | 100 cfm | T-Handle | Optional 83-1290 gauge 0 - 150 psi | 237-904 | 77-2787 |
| JGHV-453 / KK-4980 | n/a | Knob | Optional GA-355 gauge 0-30 psi | None | SB-6-102 |
| HAR-501 | 15 cfm | T-Handle | None | KK-4200 | SB-6-131 |
| 849315 | 172 scfm | Knob | Includes GA-338 gauge 0-160 psi | None | 876125 |
| 85-441 | n/a | Knob | Includes 85-70 gauge 0-60 psi | 85-438 | 77-2901 |
| 85-502 | 220 scfm | Knob | None | 85-511 | None |

Air Supply Controls & Gauges

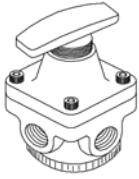

85-215

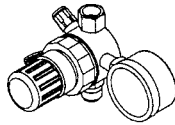

85-435

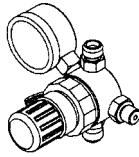

85-440

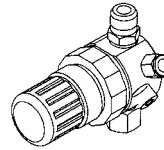

85-448

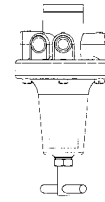

HAR-511



HAR-508

Bypass Air Regulators

| Part Number | Description | Inlet | Outlet(s) | Inlet Press. Max. | Outlet Press. Min. | Outlet Press. Max. |
|-------------|-------------------|------------------------------------|---|-------------------|--------------------|--------------------|
| 85-215 | Air regulator | 1/4" npt(f) | 2 ea 1/4" npt(f) regulated 1 ea 1/4" npt(f) unregulated | n/a | 0 psi | 100 psi |
| 85-435 | Air regulator kit | 1/4" nps(m) | 1 ea 1/4" nps(m) unregulated 1 ea 3/8"-24 (m) regulated 2 ea 1/8" npt(f) regulated | 95 psi | 0 psi | 15 psi |
| 85-440 | Air regulator | 1/2" npt w/ 1/4" nps(m) conn | 1/8" npt(f) unregulated w/ 1/4" nps(f) swivel 1/8" npt(f) regulated w/ 7/16-24 (m) conn 1/8" npt(f) regulated w/ 85-70 gauge 1/8" npt(f) regulated w/ 85-243 55 psi safety valve | 95 psi | 0 psi | 50 psi |
| 85-445 | Air regulator | 1/2" npt w/ 1/4" nps(m) conn | 1/8" npt(f) unregulated w/ 1/4" nps(f) swivel 1/8" npt(f) regulated w/ 3/8-24 (f) conn 1/8" npt(f) regulated w/ 85-70 gauge 1/8" npt(f) regulated w/ 85-243 55 psi safety valve | 95 psi | 0 psi | 50 psi |
| 85-448 | Air regulator | 1/4" nps(m) | 1 ea 1/4" nps(f) 1 ea 1/4" tubing connection | 300 psi | 0 psi | 50 psi |
| HAR-511 | Air regulator | 3/8" npt(f) | 1/4" npt(f) regulated 3/8" npt(f) regulated 2 1/4" npt(f) unregulated | 150 psi | 0 psi | 125 psi |
| HAR-508 | Air regulator | 1/2" npt(f) | 2 ea regulated 1/4" npt(f) 1 ea 1/2" npt(f) unregulated | 300 psi | 0 psi | 160 psi |

7

HAR-400 Regulator Lockout Accessory

Used with any HAR, T Handle style air regulators.

This device allows the painter to set their air regulators to guarantee proper atomization, as well as to assure compliance in areas where air cap pressure is limited to 10 psi or less. Includes one key per unit.

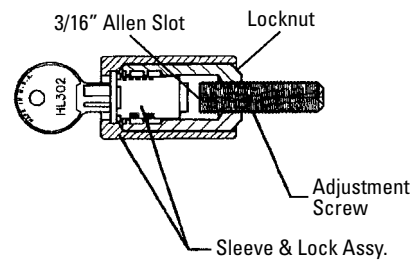

Air Supply Controls & Gauges

Bypass Air Regulators

| Part Number | Where Used | Capacity | Type | Gauge | Repair Kit | Service Form |
|----------------|--|-----------------|----------|---|------------|--------------|
| 85-215 | Pogo pump, 41-15931 air control | 30 cfm | Knob | Optional 83-2727 gauge 0-100 | 6-207 | 77-1890 |
| 85-435 | 80-511 1 qt. cup, 98-1141 outfit | n/a | Knob | Includes GA-313 gauge 0-15 plus 35 psi safety valve | 85-437 | 77-2816 |
| 85-440 | 80-295 cup | n/a | Knob | Includes 85-70 gauge 0-60 plus 35 psi safety valve | 85-438 | 77-2817 |
| 85-445 | 80-294 pressure cup | n/a | Knob | Includes 85-70 gauge 0-60 plus 35 psi safety valve | 85-438 | 77-2818 |
| 85-448 | 80-651 cup, agitator assembly | n/a | Knob | none | 85-437 | 77-2843 |
| HAR-511 | Pressure tanks | 60 cfm | T-handle | Optional 83-1290 gauge 0-150 | KK-4977 | 77-2781 |
| HAR-508 | DAD-503 air station, DAD-504 air station, HAF-601 air station, Air Vizor | 28 cfm @ 60 psi | Knob | Optional GA-316 gauge 0-160 | KK-5045 | SB-6-133 |

Air Supply Controls & Gauges

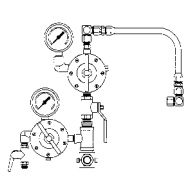

41-11459

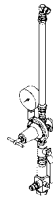

41-4279

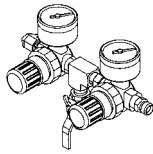

41-17235

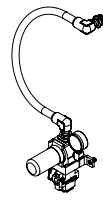

41-28080

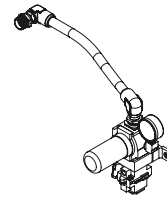

41-28081

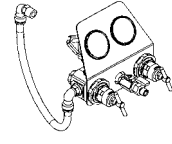

0115-010180

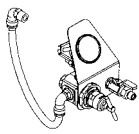

0115-010198

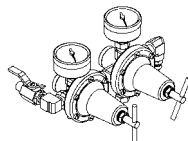

85-466

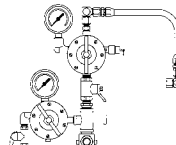

41-15922

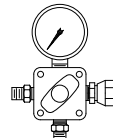

41-15931

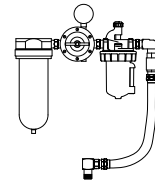

41-3189

Air Control Assemblies (Pumps)

| Part Number | Description | Pump Air Regulator | Atomizing Air Regulator | Assembly Used On | Max. Working Pressure | Mounting Type | Inlet / Outlet Fitting Sizes | Service Form |
|-------------|---|--------------------|-------------------------|----------------------------------|-----------------------|----------------------|------------------------------|---------------------|
| 41-11459 | Dual air reg set | HAR-507 | HAR-507 | Binks 6" Air mtrs and smaller | 100 PSI | Cart / Wall | 3/8" | SB-6-147 |
| 41-4279 | Single air reg set | HAR-507 | n/a | Binks 6" Air mtrs and smaller | 100 PSI | Cart / Wall | 3/8" | 77-1737, SBBI-6-147 |
| 41-17235 | Dual air reg set | HAR-503-2 | HAR-503-2 | Binks Comet 4/12 Series | 100 PSI | Pump | 1/4" | 77-2887, SB-6-105 |
| 41-28080 | Single air reg set | 85-502 | n/a | Binks BX Series | 100 PSI | Cart | 3/4" | 77-2901 |
| 41-28081 | Single air reg set | 85-502 | n/a | Binks BX Series | 100 PSI | Wall | 3/4" | 77-2901 |
| 0115-010180 | Dual air reg set | 0115-010183 | 0115-010182 | Binks MX 4/12 Series and MX 4/32 | 116 PSI | Cart / Wall / Tripod | 3/8" | 77-2912, 77-2913 |
| 0115-010198 | Single air reg set | 0115-010183 | n/a | Binks MX 4/12 Series and MX 4/32 | 116 PSI | Cart / Wall | 3/8" | 77-2912, 77-2913 |
| 85-466 | Dual air reg set | HAR-511 | HAR-507 | Binks DVP Pumps | 100 PSI | Pump | 3/8"x1/4" | 77-2781, SBBI-6-147 |
| 41-15922 | Dual air reg set | HAR-507 | HAR-507 | Binks Comet 3B | 80 PSI | Cart / Wall | 3/8" | SB-6-147 |
| 41-15931 | Single air reg set | 85-215 | n/a | Binks Pogo Pumps | 100 PSI | Pump | 1/4" | 77-1890 |
| 41-3189 | Single air reg, filter and lubricator set | 237-635 | n/a | Binks Exel Pumps | 100 PSI | Wall | 1/2" | 77-2787 |

Air Supply Controls & Gauges

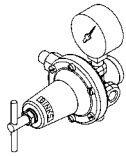

PT-413

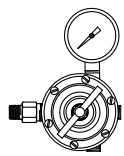

QMS-436

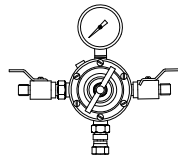

QMS-4006

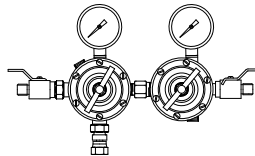

QMS-4007

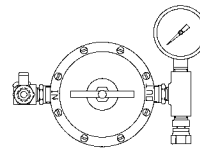

QMS-4010

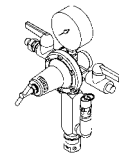

85-203

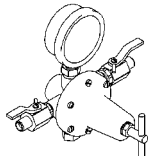

85-470, 85-471

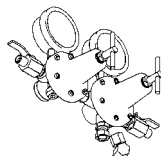

85-472, 85-473



85-490, 85-491



85-492



85-493

Air Control Assemblies (Pressure Tanks)

| Part Number | Description | Tank Air Regulator | Atomizing Air Regulator | Assembly Used On Tanks | Max. Working Pressure | Inlet / Outlet Fitting Sizes | Service Form |
|-----------------|--|--------------------|-------------------------|----------------------------------|-----------------------|------------------------------|--------------------|
| PT-413 | Conversion kit for dual | n/a | HAR-507 | PT 2.8 (80lb tanks) | 80 PSI | 1/4"nps | SBBI-21-921 |
| QMS-436 | Conversion kit for dual | n/a | HAR-507 | 83- 2.8 through 60 gal (110 psi) | 100 PSI | 1/4"nps | SBBI-21-913 |
| QMS-4006 | Single regulator kit | HAR-511 | n/a | 83- 2.8 thru 15 gal (110 psi) | 100 PSI | 1/4"nps | SBBI-21-XXX |
| QMS-4007 | Dual regulator kit | HAR-511 | HAR-507 | 83- 2.8 through 15 gal (110 psi) | 100 PSI | 1/4"nps | SBBI-21-XXX |
| QMS-4010 | Extra sensitive single kit | HAR-501 | n/a | 83- 2.8 through 15 gal (110 psi) | 100 PSI | 1/4"nps | SB-6-131 |
| 85-203 | Single air reg kit | HAR-511 | n/a | 83- 30 through 60 gal (110 psi) | 100 PSI | 1/4"nps | 77-1827 |
| 85-470 | Single regulator (non agitated tank) | HAR-511 | none | 183- 2 through 15 gal (110 psi) | 100 PSI | 1/4"nps | 77-2927 77-2928 |
| 85-471 | Single regulator (agitated tank) | HAR-511 | none | 183- 2 through 15 gal (110 psi) | 100 PSI | 1/4"nps | 77-2927 77-2928 |
| 85-472 | Double regulator (non agitated tank) | HAR-511 | HAR-507 | 183- 2 through 15 gal (110 psi) | 100 PSI | 1/4"nps | 77-2927 77-2928 |
| 85-473 | Double regulator (agitated tank) | HAR-511 | HAR-507 | 183- 2 through 15 gal (110 psi) | 100 PSI | 1/4"nps | 77-2927 77-2928 |
| 85-490 | Extra sensitive single regulator (non agitated tank) | HAR-501 | none | 183- 2 through 15 gal (110 psi) | 30 PSI | 1/4"nps | 77-2927 77-2928 |
| 85-491 | Extra sensitive single regulator (agitated tank) | HAR-501 | none | 183- 2 through 15 gal (110 psi) | 30 PSI | 1/4"nps | 77-2927 77-2928 |
| 85-492 | Extra sensitive double regulator (non agitated tank) | HAR-501 | HAR-507 | 183- 2 through 15 gal (110 psi) | 30 PSI | 1/4"nps | 77-2927 77-2928 |
| 85-493 | Extra sensitive double regulator (agitated tank) | HAR-501 | HAR-507 | 183- 2 through 15 gal (110 psi) | 30 PSI | 1/4"nps | 77-2927 77-2928 |

Air Supply Controls & Gauges

DeVilbiss offers a complete line of quality air filtering units

It's the equipment you need to ensure a contaminant-free material application — because today's high solids and waterbornes are even more sensitive to contaminants. The right filter equipment from DeVilbiss can make all the difference.

The fact is, an otherwise great finish can be totally ruined by just a small amount of dirt, oil or water in your air line. And needless to say, flaws like pinholes, blushing, fisheyes or dulling mean a job has to be redone—a waste of both time and money.

Quality Equipment and Proper Installation

Following some key installation principles will help decrease the risk of contaminants:

- It's important to use the right size air compressor for your application. An overworked air compressor can produce a significant amount of dirt and oil.

- Proper piping is very important to help prevent condensation from forming within the line and contaminating the air supply.

DeVilbiss is ready to assist you with any questions.



Centrifugal Air Filters

| Part Number | Description | Inlet | Outlet(s) | Inlet Press. Max. | Outlet Press. Min. | Outlet Press. Max. |
|-------------|------------------------|-------------|-------------|-------------------|--------------------|--------------------|
| HAF-502 | Centrifugal air filter | 1/2" npt(f) | 1/2" npt(f) | 150 psi | 0 psi | 150 psi |
| HAF-503 | Centrifugal air filter | 3/4" npt(f) | 3/4" npt(f) | 150 psi | 0 psi | 150 psi |
| HAF-505 | Coalescing air filter | 1/2" npt(f) | 1/2" npt(f) | 150 psi | 0 psi | 150 psi |

Air Supply Controls & Gauges

Recommended Air Supply Setup

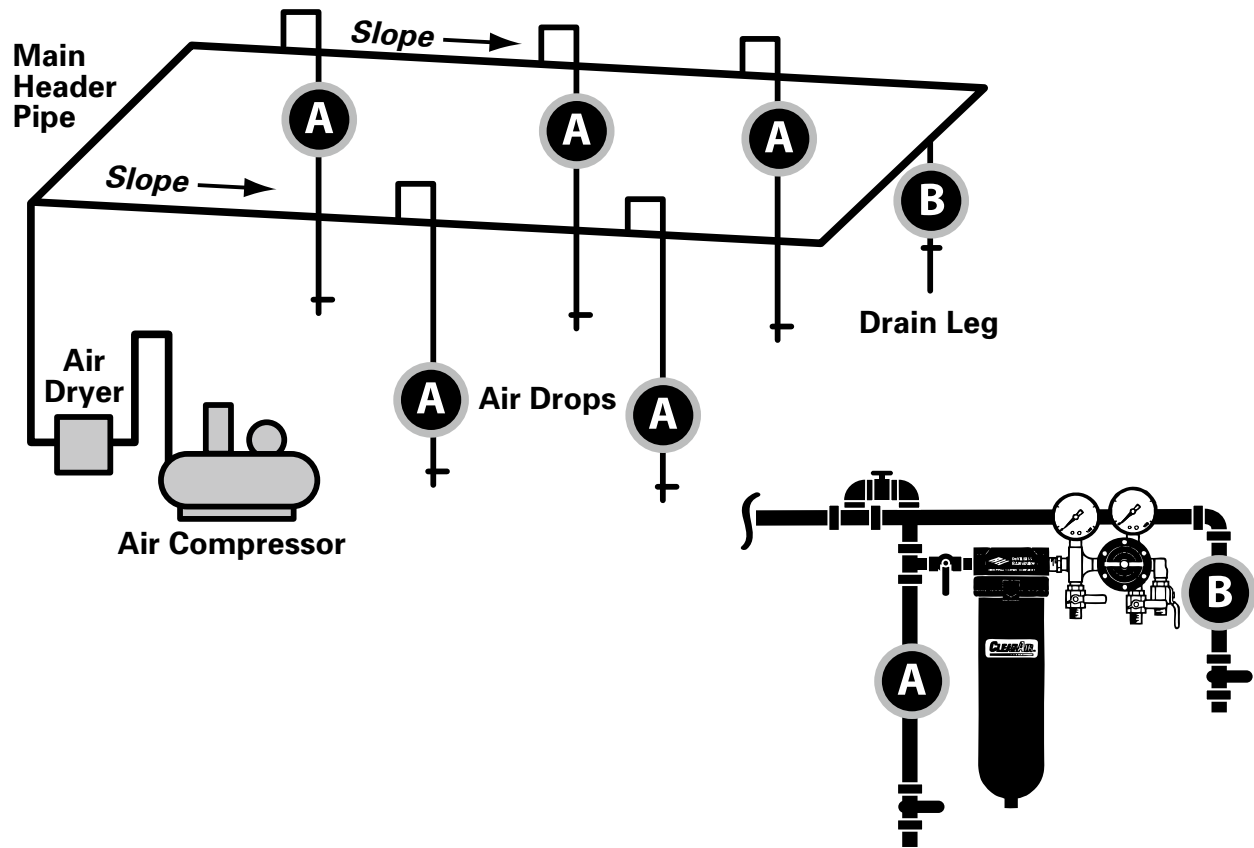

Centrifugal Air Filters

| Part Number | Capacity | Type | Gauge | Repair Kit | Service Form |
|-------------|--------------------|---------|-------|------------|--------------|
| HAF-502 | 100 cfm@ 90 psi | In-line | None | None | SB-6-146 |
| HAF-503 | 150 cfm@ 90 psi | In-line | None | None | SB-6-148 |
| HAF-505 | 55 cfm@ 90 psi | In-line | None | None | SB-6-152 |

Air Supply Controls & Gauges

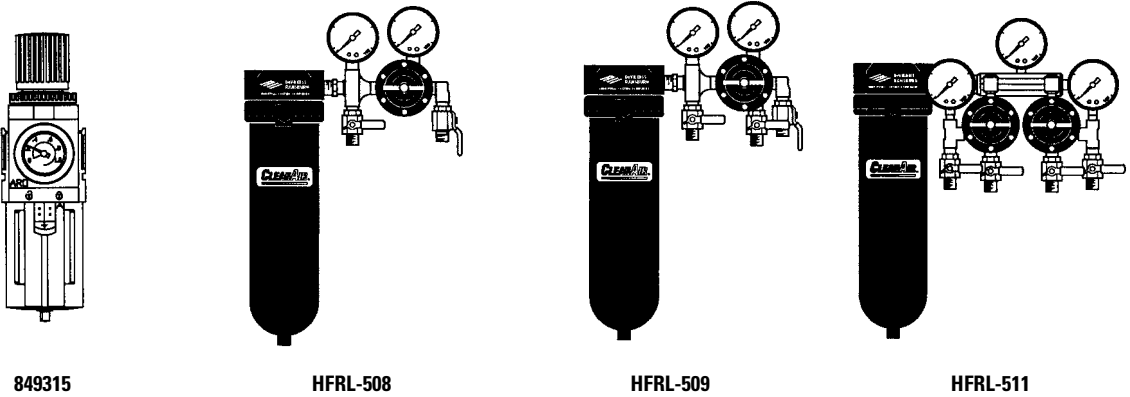

Centrifugal Filter/Regulator Units

| Part Number | Description | Inlet | Outlet(s) | Inlet Press. Max. | Outlet Press. Min. | Outlet Press. Max. |
|-------------|-------------------------------------|-------------|---|-------------------|--------------------|--------------------|
| 849315 | Piggyback filter / air regulator | 1/2" npt(f) | 1/2" npt(f) | 250 psi | 5 psi | 140 psi |
| HFRL-508 | Centrifugal filter / regulator unit | 1/2" npt(f) | 2 ea 1/4" nps(m) regulated and 1 ea 1/4" nps(m) non-regulated | 150 psi | 0 psi | 150 psi |
| HFRL-509 | Centrifugal filter / regulator unit | 3/4" npt(f) | 2 ea 1/4" nps(m) regulated and 1 ea 1/4" nps(m) non-regulated | 150 psi | 0 psi | 150 psi |
| HFRL-511 | Centrifugal filter / regulator unit | 3/4" npt(f) | 4 ea 1/4" nps(m) regulated and 1 ea 1/4" nps(m) non-regulated | 150 psi | 0 psi | 150 psi |

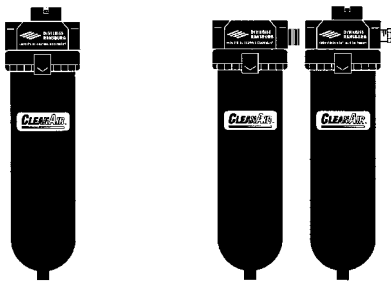

HAF-508

HAF-509

DeVilbiss CleanAir centrifugal units supply cleaner, drier air to each spray gun in a system. This cleaner air can also increase the life of pneumatic tools.

- Filters out water and oil aerosols and dirt particulates to 5 microns.
- Ideal for most spray applications, air tools and equipment.
- Water droplets collected in the bowl are removed by an automatic drain (standard feature). No need to manually drain.

Coalescer and Centrifugal/Coalescer Filter Units

| Part Number | Description | Inlet | Outlet(s) | Inlet Press. Max. | Outlet Press. Min. | Outlet Press. Max. |
|-------------|-------------------------------------|-------------|-------------|-------------------|--------------------|--------------------|
| HAF-508 | Coalescer filter unit | 3/4" npt(f) | 3/4" npt(f) | 150 psi | 0 psi | 150 psi |
| HAF-509 | Centrifugal & coalescer filter unit | 3/4" npt(f) | 3/4" npt(f) | 150 psi | 0 psi | 150 psi |

Air Supply Controls & Gauges

Centrifugal Filter/Regulator Units

| Part Number | Capacity | Type | Gauge | Dimensions | Repair Kit | Service Form |
|-------------|----------|------------------------------|--------------------|-----------------------------|------------|--------------|
| 849315 | 172 CFM | Piggyback filter / regulator | GA-338 / 0-160 psi | n/a | 863023 | 876125 |
| HFRL-508 | 60 Plus | In-line | GA-288 / 83-2727 | n/a | KK-4977 | SB-6-146 |
| HFRL-509 | 80 Plus | In-line | GA-288 / 83-2727 | 10-3/4" wide x 17-3/4" high | KK-4977 | SB-6-148 |
| HFRL-511 | 120 Plus | In-line | GA-288 / 83-2727 | 12-1/2" wide x 17-1/2" high | KK-4977 | SB-6-148 |

CleanAir coalescer filters remove water, dirt and oil from the system down to .01 micron. DeVilbiss coalescer filter units are designed with a quick-release bowl and spin-off element for filter changes without tools. In addition, a filter-change indicator alerts the operator when the element requires changing.

- Borosilicate glass microfiber filter is engineered for high flow, high efficiency, quick change and low pressure drop.
- Ideal for most spray applications, especially where oil aerosols may be a problem.
- Automatic bowl drain and 6' hose eliminate oil and water buildup (standard feature). No need to manually drain.

Coalescer and Centrifugal/Coalescer Filter Units

| Part Number | Capacity | Type | Gauge | Dimensions | Repair Kit | Service Form |
|-------------|----------|---------|-------|----------------------------|------------|--------------|
| HAF-508 | 150 cfm | In-line | None | 4-1/2" wide x 13-3/4" high | KK-4977 | SB-6-148 |
| HAF-509 | 150 cfm | In-line | None | 9-1/2" wide x 13-3/4" high | KK-4977 | SB-6-148 |

Air Supply Controls & Gauges

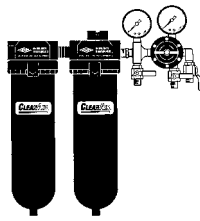

HFRL-512

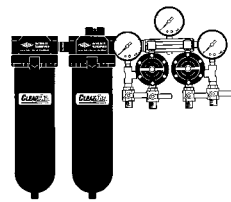

HFRL-513

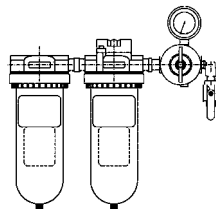

HAF-518

Centrifugal/Coalescer/Filter Regulator Units

| Part Number | Description | Inlet | Outlet(s) | Inlet Press. Max. | Outlet Press. Min. | Outlet Press. Max. |
|-------------|---|-------------|--|-------------------|--------------------|--------------------|
| HFRL-512 | CENTRIFUGAL - coalescer - filter regulator unit | 3/4" npt(f) | 2ea 1/4" nps(m) regulated and 1, 1/4" nps(m) non-regulated | 150 psi | 0 psi | 150 psi |
| HFRL-513 | CENTRIFUGAL - coalescer - filter regulator unit | 3/4" npt(f) | 4ea 1/4" nps(m) regulated | 150 psi | 0 psi | 150 psi |
| HAF-518 | CENTRIFUGAL - coalescer - filter regulator unit | 3/4" npt(f) | 1ea 1/4" nps(m) regulated | 150 psi | 0 psi | 150 psi |

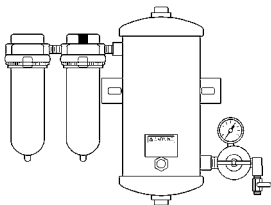

The three-stage desiccant unit provides the ultimate in clean dry air. First stage centrifugal filter removes particulates to 5 microns. Stage two coalescer filters down to .01 micron. Third stage desiccant removes remaining water vapor to a dew point of -40°F.

- Ideally suited for low to medium production.
- DAD-500 air-drying system includes three filtering units, as well as a wall mount bracket and desiccant filter change indicator.

3 Stage Desiccant Filter Unit

| Part Number | Description | Inlet | Outlet(s) | Inlet Press. Max. | Outlet Press. Min. | Outlet Press. Max. |
|-------------|-----------------------------|-------------|-----------------------|-------------------|--------------------|--------------------|
| DAD-500 | 3 Stage desiccant air dryer | 1/2" npt(f) | 1/4" nps(m) regulated | 150 psi | 0 psi | 150 psi |

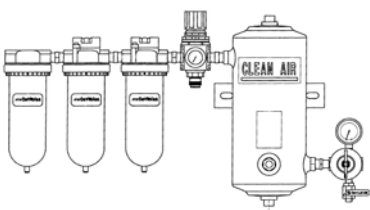

- Converts shop air into clean, dry, contaminant-free air for breathing systems and spray operations
- 5 micron particulate filter (Stage 1)

- .01 micron coalescing filter (Stage 2)
- Charcoal filter for hydrocarbon and odor removal (Stage 3)
- 28 cfm breathing air regulator

4 Stage Desiccant Filter Unit

| Part Number | Description | Inlet | Outlet(s) | Inlet Press. Max. | Outlet Press. Min. | Outlet Press. Max. |
|-------------|--|-------------|--|-------------------|--------------------|--------------------|
| DAD-503 | 4 Stage desiccant air dryer breathable | 1/2" npt(f) | 1/4" nps(m) regulated & breathable air outlet quick disconnect | 150 psi | 0 psi | 150 psi |

Air Supply Controls & Gauges

Coalescer/Filter Regulator Units

| Part Number | Capacity | Type | Gauge | Dimensions | Repair Kit | Service Form |
|-----------------|----------|---------|---------------------|-----------------------------|------------|------------------------------|
| HFRL-512 | 80 Plus | In-line | GA-372 / GA-373 | 15-3/4" wide x 17-3/4" high | KK-4977 | SB-6-145, SB-6-148 |
| HFRL-513 | 120 Plus | In-line | GA-372 / 2ea GA-373 | 21" wide x 17-1/2" high | KK-4977 | SB-6-145, SB-6-148 |
| HAF-518 | 55 cfm | In-line | GA-288 | | KK-4977 | SB-6-146, SB-6-152, SB-6-140 |

- Centrifugal and coalescer units include automatic bowl drain (standard feature). No need to manually drain.
- Coalescer filter includes filter change indicator.
- Desiccant filter includes sight glass indicator (Changes color when desiccant needs replacement).

3 Stage Desiccant Filter Unit

| Part Number | Capacity | Type | Gauge | Shipping Weight | Repair Kit | Service Form |
|----------------|----------|--------------------------|--------|-----------------|------------|--------------|
| DAD-500 | 25 cfm | Key / t-handle / in-line | GA-288 | 35 lbs | KK-4977 | SB-6-156 |

- Desiccant system removes water vapor for spray gun (rated for 25 cfm maximum flow)
- 60 cfm spray gun regulator
- Automatic drains (Stages 1, 2 and 3)
- Can be used with up to four Air Vizors

4 Stage Desiccant Filter Unit

| Part Number | Capacity | Type | Gauge | Repair Kit | Service Form |
|----------------|-----------------|--------------------------|-----------------|-----------------------|--------------|
| DAD-503 | 25 cfm / 60 cfm | Key / t-handle / in-line | GA-288 / GA-316 | KK-5045 diaphragm kit | SB-6-159 |

Air Supply Controls & Gauges

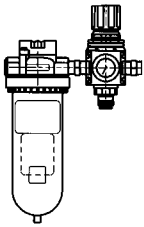

DAD-504

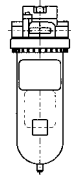

HAF-517

- Converts DAD-500 into a breathing air source
- Charcoal filter for hydrocarbon and odor removal
- 28 cfm breathing air regulator. Includes all necessary fittings
- Can be used with up to four DeVilbiss Air Vizors
- Automatic drain

1 Stage Charcoal Filter with Regulator

| Part Number | Description | Inlet | Outlet(s) | Inlet Press. Max. | Outlet Press. Min. | Outlet Press. Max. |
|-------------|---|-------------|-------------|-------------------|--------------------|--------------------|
| DAD-504 | 1 Stage charcoal filter and regulator kit | 1/2" npt(f) | 1/2" npt(m) | 150 psi | 0 psi | 150 psi |
| HAF-517 | 1 Stage charcoal filter only | 1/2" npt(f) | 1/2" npt(f) | 150 psi | 0 psi | 150 psi |

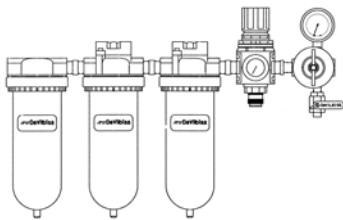

- Converts shop air into clean, contaminant-free air for breathing systems and spray operations
- 5 micron particulate filter (Stage 1)
- .01 micron coalescing filter (Stage 2)
- Charcoal filter for hydrocarbon and odor removal (Stage 3)
- 28 cfm breathing air regulator
- 60 cfm spray gun regulator

3 Stage Breathing Air Filter with Regulators

| Part Number | Description | Inlet | Outlet(s) | Inlet Press. Max. | Outlet Press. Min. | Outlet Press. Max. |
|-------------|--|-------------|--|-------------------|--------------------|--------------------|
| HAF-601 | 3 Stage breathing air filter with regulators | 1/2" npt(f) | 1/4" nps(m) & breathable air outlet quick disconnect | 150 psi | 0 psi | 150 psi |



A unique product in the finishing market

- FRC-650 All-In-One combines a filter, regulator and coalescer for shop air into one compact unit.
- Four 1/4" nps(m) ball valves with unrestricted air passages, (three regulated plus one unregulated outlet.)

2 Stage Filter/Regulator and Coalescer

| Part Number | Description | Inlet | Outlet(s) | Inlet Press. Max. | Outlet Press. Min. | Outlet Press. Max. |
|-------------|---|-------------|--|-------------------|--------------------|--------------------|
| FRC-650 | All in one – filter, regulator, coalescer | 1/2" npt(f) | 1/4" nps(m) 3 reg & 1 main line air | 150 psi | 0 psi | 125 psi |

Air Supply Controls & Gauges

1 Stage Charcoal Filter with Regulator

| Part Number | Capacity | Type | Gauge | Repair Kit | Service Form |
|----------------|----------|----------------|--------|------------|--------------|
| DAD-504 | 28 cfm | Knob / in-line | GA-316 | See lit | SB-6-176 |
| HAF-517 | 28 cfm | N/A | N/A | N/A | SB-6-176 |

- Automatic drains (Stages 1, 2 and 3)
- Wall-mount bracket
- Can be used with up to four Air Visors

3 Stage Breathing Air Filter with Regulators

| Part Number | Capacity | Type | Gauge | Repair Kit | Service Form |
|----------------|-----------------|---------------------------|-----------------|------------|--------------|
| HAF-601 | 28 cfm / 60 cfm | Knob / t-handle / in-line | GA-288 / GA-316 | See lit | SB-6-132 |

- Ball valves inclined 45°—avoids kinking of hoses, which increases life span.
- Robust and durable.
- Solvent-resistant filter bowl and body is indispensable in the spray area.
- Solvent- and slip-resistant knob for easy air adjustment.
- Automatic drains at each stage eliminate water build-up—no need to manually drain.

2 Stage Filter/Regulator and Coalescer

| Part Number | Capacity | Type | Gauge | Repair Kit | Service Form |
|----------------|----------|------|-------------------|------------|--------------|
| FRC-650 | 100 cfm | Knob | FRC-012 / FRC-046 | K-4106/7/8 | SB-6-377 |

Air Supply Controls & Gauges

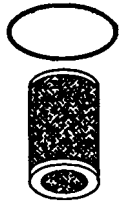

HAF-6, HAF-15,
HAF-28, HAF-36



HAF-38



Filter Element Kits / Mounting Hardware Kits

| Filter Assy. Part Number | Filter Element Kit | Mounting Hardware Kit Optional Parts | Service Form |
|--------------------------|------------------------------|--------------------------------------|--------------|
| DAD-500 | HAF-6, HAF-28, DAD-1 | n/a | SB-6-156 |
| DAD-503 | HAF-6, HAF-28, HAF-36, DAD-1 | HAF-407 | SB-6-159 |
| DAD-504 | K-4106 | K-4107 | SB-6-377 |
| FRC-650 | HAF-36 | n/a | SB-6-176 |
| HAF-502 | HAF-6 | HAF-407 | SB-6-146 |
| HAF-503 | HAF-15 | HAF-408 | SB-6-148 |
| HAF-505 | HAF-28 | n/a | SB-6-152 |
| HAF-508 | HAF-38 | HAF-408 | SB-6-148 |
| HAF-509 | HAF-15, HAF-38 | HAF-408 | SB-6-148 |
| HAF-601 | HAF-6, HAF-28, HAF-36 | HAF-407 | SB-6-132 |
| HFRL-508 | HAF-6 | HAF-407 | SB-6-146 |
| HFRL-509 | HAF-15 | HAF-408 | SB-6-148 |
| HFRL-511 | HAF-15 | HAF-408 | SB-6-148 |
| HFRL-512 | HAF-15, HAF-38 | HAF-408 | SB-6-148 |
| HFRL-513 | HAF-15, HAF-38 | HAF-408 | SB-6-148 |
| 849303 | 873209 | 849305 | 849303 |
| 849315 | 863022 | n/a | 876125 |

Air Vizor™ Breathable Air Systems & Filtration Units

| Order No. Model No. | Belt Regulator and Hood Assembly | Breathable Air Hose (30') | No. of Visor Covers Included | Filtration Unit Included | Filtration Description |
|---------------------|----------------------------------|---------------------------|------------------------------|--------------------------|--|
| MPV-625 | Yes | No | 2 | None | — |
| MPV-650 | Yes | Yes | 12 | DAD-504 | Desiccant Retrofit System |
| MPV-651 | Yes | Yes | 12 | DAD-503 | 3 Stage Filtration with Desiccant Air Dryer System |
| MPV-652 | Yes | Yes | 12 | HAF-601 | 3 Stage Filtration System |

*Air Vizor™ requires proper air line filtration and carbon monoxide (CO) monitoring to complete an approved supplied air respirator. See descriptions at right for proper air line filtration.

A carbon monoxide (CO) monitor may be purchased locally or from ENMET Corporation: (734) 761-1270 (phone). Order form F-1073-C available from DeVilbiss upon request.



The filtration units above are only one part of a complete breathable air system. These must be combined with a supplied air respirator and Grade D breathable air. A carbon monoxide (CO) monitor must also be used.

Air Supply Controls & Gauges



GA-288



GA-385



849306

Air Pressure Gauges

| Part No. | Capacity Pressure | Thread Size & Position | | Notes |
|----------|-------------------|------------------------|-------------|---|
| | | Bottom | Back | |
| 59-299 | 15 | | 1/8" npt(m) | Panel mount, 1-1/2" diameter |
| 83-1636 | 15 | 1/4" npt(m) | | 2-11/16" diameter |
| GA-313 | 15 | 1/8" npt(m) | | 1-1/2" diameter |
| 83-1414 | 30 | 1/4" npt(m) | | 2-1/2" diameter |
| GA-73 | 30 | 1/4" npt(m) | | 2" diameter |
| GA-355 | 30 | 1/8" npt(m) | | 1-1/2" diameter |
| 59-369 | 60 | | 1/8" npt(m) | Panel mount, 1-1/2" diameter |
| 85-70 | 60 | 1/8" npt(m) | | 1-5/8" diameter, replacement lens 85-130-5 |
| 83-1355 | 100 | 1/4" npt(m) | | Plated stem, 2-1/2" diameter |
| 83-2727 | 100 | 1/4" npt(m) | | 83-2290 (Lens), 2-3/16" diameter |
| GA-385 | 100 | | 1/4" npt(m) | 2" diameter |
| 83-1290 | 150 | 1/4" npt(m) | | Used on tanks, 2-1/2" diameter, replacement lens 83-2052 |
| GA-288 | 160 | 1/4" npt(m) | | 2" diameter |
| GA-316 | 160 | | 1/4" npt(m) | 2" diameter |
| GA-338 | 160 | | 1/8" npt(m) | 1-1/2" diameter (replacement gauge for 849315 filter regulator) |
| 849306 | 160 | | 1/4" npt(m) | Used on Infinity 849303 filter / regulator |
| 83-2744 | 200 | 1/4" npt(m) | | 2-11/16" diameter |
| 83-387 | 200 | 1/4" npt(m) | | 83-2052 (Lens), 2-1/2" diameter |

Cups & Cup Accessories

| | |
|-------------------------------------|------------|
| SIPHON CUPS | 8-2 |
| PRESSURE CUPS | 8-3 |
| GRAVITY FEED CUPS | 8-4 |
| REMOTE PRESSURE CUPS | 8-5 |
| DEKUPS DISPOSABLE CUP SYSTEM | 8-6 |
| CUP ACCESSORIES | 8-8 |
| CUP GASKETS | 8-8 |

Cups & Cup Accessories

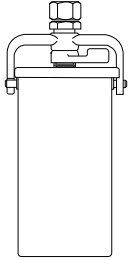

81-540

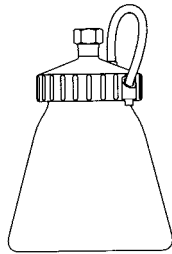

81-384

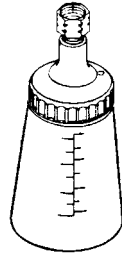

TGS-503



TGS-503

Siphon Cups – 1/4" nps Thread For Touch-up Guns

| Part Number | Capacity | Wetted Materials | Type | Notes | Service Form |
|-------------|----------|------------------|------------|----------------------|--------------|
| 81-540 | 8 oz | Aluminum | Standard | | 77-1261 |
| 81-384 | 8 oz | Polyethylene | Drip proof | | 77-2741 |
| TGS-503 | 8 oz | Polyethylene | Standard | | SB-4-090 |
| TGS-406 | 8 oz | Polyethylene | Standard | Storage cup with lid | n/a |

NOTE: To use on full size spray guns, use adapter P-H-4105.

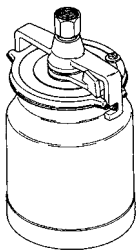

TGC-545, TLC-555,
TSC-595

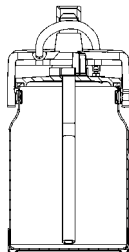

81-800, 81-810



81-820

Siphon Cups – 3/8" nps Thread For Full Size Guns

| Part Number | Capacity | Wetted Materials | Type | Guns Used With | Service Form |
|-------------|----------|-------------------|------------|--------------------|--------------|
| TGC-545 | 1 qt | Aluminum | Drip-free | All full size guns | SB-4-391 |
| 81-800 | 1 qt | Aluminum | Drip proof | All full size guns | 77-2794 |
| TLC-555 | 1 qt | Alum-teflon lined | Drip-free | All full size guns | SB-4-391 |
| 81-810 | 1 qt | Alum-teflon lined | Drip proof | All full size guns | 77-2795 |
| TSC-595 | 1 qt | Stainless steel | Drip-free | All full size guns | SB-4-395 |
| 81-820 | 1 qt | Stainless steel | Drip proof | All full size guns | 77-2821 |

Cups & Cup Accessories

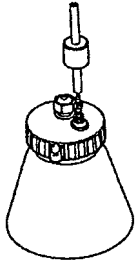

81-382

Pressure Cup (gun attached) – 1/4" nps Thread For Mach 1 Cub and CubSL only

| Part Number | Capacity | Wetted Materials | Max. Pressure | Guns Used With | Service Form |
|-------------|----------|------------------|---------------|--------------------------|--------------|
| 81-382 | 8 oz | Polyethylene | 10 psi | MACH 1 Cub & Cub SL only | 77-2724 |

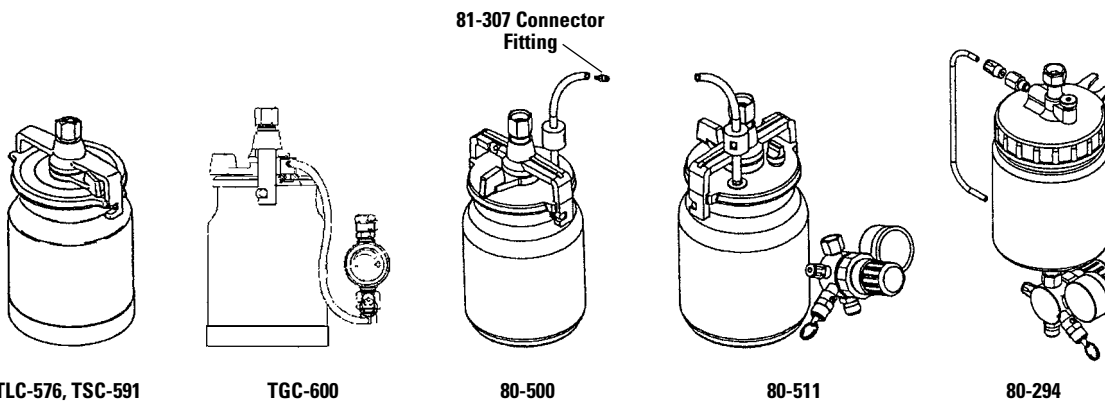

Pressure Cups (gun attached) – 3/8" nps Thread For Full Size Guns

| Part Number | Capacity | Wetted Materials | Max. Pressure | Notes | Service Form |
|-------------|----------|-------------------|---------------|---|--------------|
| TLC-576 | 1 qt | Aluminum / Teflon | 20 psi | Requires KK-4980 | SB-4-367 |
| TGC-600 | 1 qt | Aluminum | 20 psi | Includes KK-4980 | SB-4-367 |
| TSC-591 | 1 qt | Stainless steel | 20 psi | Requires KK-4980 | SB-4-367 |
| 80-500 | 1 qt | Stainless steel | 20 psi | Includes short tube (MACH 1 & MACH 1SL only) and 81-507 connector fitting | 77-2820 |
| 80-510 | 1 qt | Stainless steel | 15 psi | Includes long tube (requires 85-435 regulator) | 77-2820 |
| 80-511 | 1 qt | Stainless steel | 15 psi | Includes long tube, 85-435 regulator | 77-2820 |
| 80-294 | 1 qt | Aluminum | 50 psi max | Includes tube, 85-445 regulator | 77-2822 |

Cups & Cup Accessories

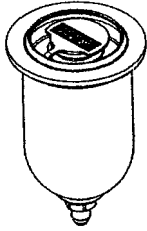

54-4458

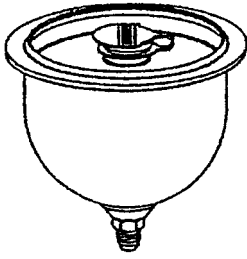

81-381

Gravity Feed Cups – 7/16" -14 (m) Thread for Touch-up Guns

| Part Number | Capacity | Wetted Materials | Service Form |
|-------------|---------------|--------------------|--------------|
| 54-4458 | 4 oz / 120 ml | Aluminum | 77-2719 |
| SRI-478-K12 | 4 oz / 120 ml | Nylon (disopsable) | SB-2-525 |
| SRI-510 | 4 oz / 120 ml | Acetal | SB-2-525 |
| 81-381 | 8 oz / 240 ml | Aluminum | 77-2739 |

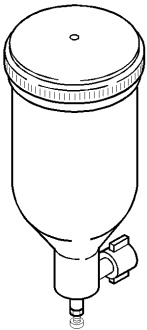

TGHV-415

Gravity Feed Cup – 1/4" -19 bsp (f) Swivel (For TGHV-635 Gun Only)

| Part Number | Capacity | Wetted Materials | Service Form |
|-------------|---------------|------------------|--------------|
| TGHV-415 | 8 oz / 240 ml | Stainless steel | SB-2-192 |

Cups & Cup Accessories

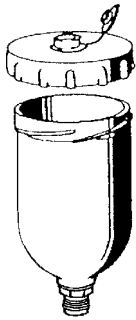

GFC-501

Gravity Feed Cups – 3/8" -19 bsp (m) Thread For Full Size Guns

| Part Number | Capacity | Wetted Materials | Guns Used With | Service Form |
|-------------|-----------------|-------------------------------|---|--------------|
| KGP-509-1 | 8 oz / 240 ml | Nylon | EXL, M1-G, FLG-2, FLG-3, Compact, 95G, SV-100 | SB-4-042 |
| GFC-501 | 20 oz / 590 ml | Acetal, plated brass fittings | EXL, M1-G, FLG-2, FLG-3, Compact, 95G, SV-100 | SB-4-261 |
| GFC-502 | 34 oz / 1 Liter | Aluminum | EXL, M1-G, FLG-2, FLG-3, Compact, 95G, SV-100 | SB-4-043 |
| 54-4720 | 34 oz / 1 Liter | Aluminum | EXL, M1-G, FLG-2, FLG-3, Compact, 95G, SV-100 | SBBI-4-043 |

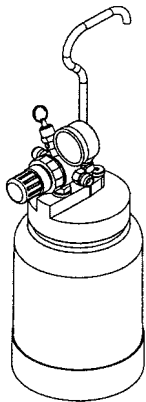

80-295

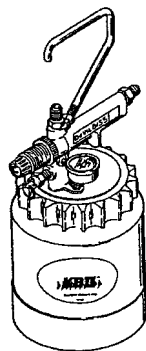

KB-555, KB-545-SS

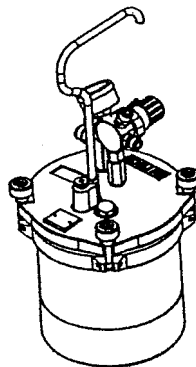

80-600, 80-601, 80-651

Pressure Cups (remote from gun)

| Part Number | Capacity | Wetted Materials | Max. Working Pressure | Notes | Service Form |
|-------------|-------------------|----------------------------|-----------------------|--|--------------|
| 80-295 | 2 Quart / 1895 ml | Aluminum | 50 psi | Single regulator (fluid pressure) | 77-2823 |
| KB-555 | 2 Quart / 1895 ml | Aluminum | 50 psi | Single regulator (fluid pressure) | SB-4-205 |
| 80-600 | 2 Quart / 1895 ml | Aluminum & stainless steel | 50 psi | Single regulator (fluid pressure) | 77-2841 |
| KB-545-SS | 2 Quart / 1895 ml | Stainless steel | 50 psi | Single regulator (fluid pressure) | SB-4-205 |
| 80-601 | 2 Quart / 1895 ml | Aluminum & stainless steel | 50 psi | Single regulator (fluid pressure), oscillating agitator | 77-2841 |
| 80-651 | 2 Quart / 1895 ml | Aluminum & stainless steel | 50 psi | Single regulator (fluid pressure) and rotary agitator w/reg. | 77-2842 |

Cups & Cup Accessories

DeKups Disposable Cup System

CUP SYSTEMS

| Part Number | Description | Notes |
|-------------|-----------------------|-----------|
| DPC-607 | Reusable frame, 9 oz | Kit of 2 |
| DPC-606 | Reusable frame, 24 oz | Kit of 2 |
| DPC-608 | Reusable frame, 34 oz | Kit of 2 |
| DPC-602 | Disposable cup, 9 oz | Kit of 32 |
| DPC-601 | Disposable cup, 24 oz | Kit of 32 |
| DPC-600 | Disposable cup, 34 oz | Kit of 32 |

GRAVITY ADAPTERS

| Part Number | Compatible Spray Gun |
|-------------|---|
| DPC-31 | Compact, JGA, EXL, FLG, M1-G, 95-G, SV100 |
| DPC-23 | SRI, Cub SLG, Compact Mini |
| DPC-10 | SV50 Full Size, Graco Finex |
| DPC-64 | SV50 Touch Up |
| DPC-43 | Graco® XT, Graco GT |
| DPC-77 | Graco® AirPro |
| DPC-78 | Kremlin® Guns |

SIPHON FEED ADAPTERS

| Part Number | Compatible Spray Gun |
|-------------|---|
| DPC-79-K1 | Siphon: Mach 1 Cub, Mach 1 Cub SL, EGA, EGHV, 115 |
| DPC-69-K1 | Siphon Conversion Adapter (full size guns) |
| DPC-500 | Converter for 3M® Adapters |

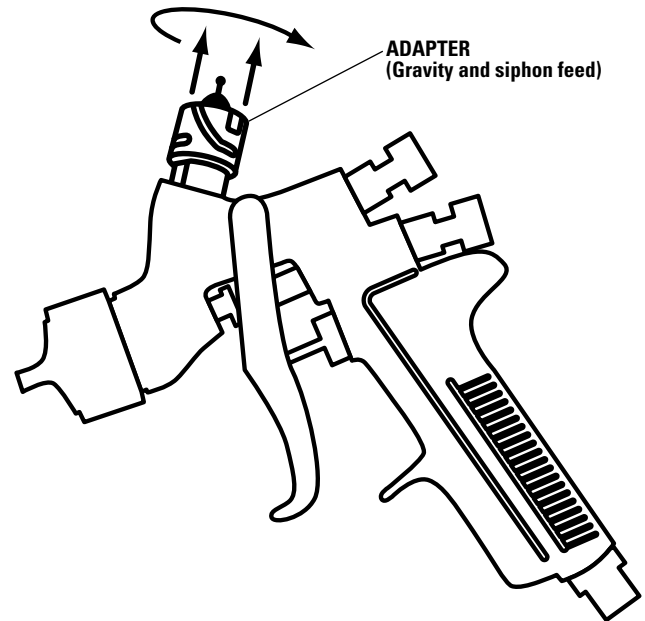
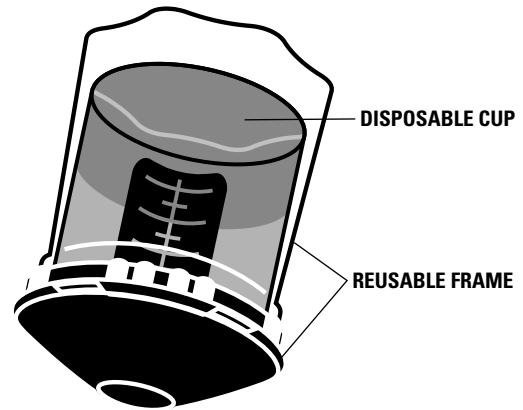

Cups & Cup Accessories

DeKups Disposable Cup System

BETTER FLUID FLOW FOR GREAT COLOR MATCH

The DeKups liner features high collapsibility, so all the paint is moved through the gun and onto the job. Save time and money, increase productivity, and waste less paint.

POSITIVE LOCKING LID

The reusable DeKups lid locks firmly into place and will not come detached from the gun while in use. No messy accidents.

REFILL WITHOUT OPENING THE CUP LID

Patented self-venting funnels allow a painter to refill without opening the cup lid. No mess on the bench during the refill process saves clean-up time, wasted paint, and money.

SELF-DISPENSING PACKAGING

The versatile dispensers mount conveniently on the wall so you can put them wherever you like. No space restrictions, no need to refill bins. Each cup and lid dispenses separately for less hassle. Save time and space.

LARGER VOLUMES

DeKups offers 9–50 percent more cup volume—which means less refills. With three different cup sizes, you can size the cup to the job, wasting less paint, saving more money.

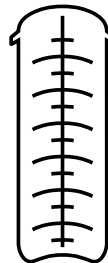

DPC-60-K10,
DPC-59-K10,
DPC-61-K10

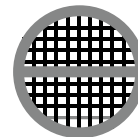

DPC-65-K24, DPC-42-K24,
DPC-67-K24, DPC-66-K24

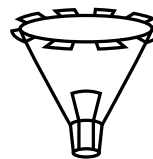

DPC-22-K24



DPC-6-K10



DPC-44

ACCESSORIES

| Part Number | Description | Notes |
|-------------|---------------------------------------|-----------|
| DPC-60-K10 | Measuring Guide 9 oz | Kit of 10 |
| DPC-59-K10 | Measuring Guide 24 oz | Kit of 10 |
| DPC-61-K10 | Measuring Guide 34 oz | Kit of 10 |
| DPC-65-K24 | Disk Filters 125 micron 9 oz | Kit of 24 |
| DPC-42-K24 | Disk Filters 125 micron 24 oz & 34 oz | Kit of 24 |
| DPC-67-K24 | Disk Filters 200 micron 9 oz | Kit of 24 |
| DPC-66-K24 | Disk Filters 200 micron 24 oz & 34 oz | Kit of 24 |
| DPC-22-K24 | Disposable Funnels | Kit of 24 |
| DPC-6-K10 | Orange Plugs | Kit of 10 |
| DPC-44 | Cleaning Brush | Each |

Cups & Cup Accessories

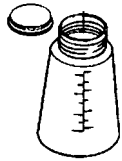

TGS-406



149-278

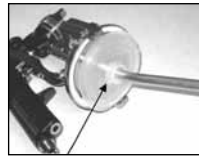

KR-115-K5



KK-5051



OMX-70-K48



KGP-5-K5



81-82, 81-83, 81-84

Cup Accessories

| Part Number | Description | Notes |
|-------------|---|-------------------------------------|
| TGS-406 | Storage cup with lid | Compatible with TGS-503 suction cup |
| 149-278 | Siphon/suction cup inlet screen 50 mesh | Fits on p/u tube, 10 Per box |
| KR-115-K5 | Diaphragm lid protector | Prevents cup leaks, package of 5 |
| KK-5051 | KB cup liners 20/pkg | For KB-545-SS & KB-555 2 qt cups |
| OMX-70-K48 | Gravity cup liners & bushings | Fits most 1 qt & 1 liter cups |
| KGP-5-K5 | Gravity cup strainers 50 mesh, | Package of 5 |
| 81-82 | 145 Mesh 1 quart cup strainers | Approximately 100 micron, box of 5 |
| 81-83 | 100 Mesh 1 quart cup strainers | Approximately 149 micron, box of 5 |
| 81-84 | 80 Mesh 1 quart cup strainers | Approximately 177 micron, box of 5 |
| 80-356 | Semi-rigid liners | For Binks SG2 cups, box of 12 |

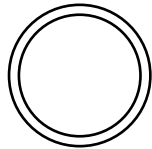

Cup Gaskets

| Part Number | Cup Model | Gasket Material | Notes |
|-------------|--|------------------------------|--------------|
| KGP-13-K5 | Gravity feed cups with 3/8" -19 bsp(m) threads | PTFE | Package of 5 |
| KB-80-K5 | KB-545SS and KB-545 | Sarlink | Package of 5 |
| TGC-9-K5 | TGC, TLC, TSC, 81-800, 81-810, 81-820, 81-500, 81-510 and 81-511 | Tri-Seal | Package of 5 |
| 55-30 | 81-540 | Leather | Each |
| TGS-4-K5 | TGS-503 | Tri-Seal | Package of 5 |
| 80-11-5 | 80-294 and 80-295 | Tri-Seal | Package of 5 |
| 80-506-K5 | TGC, TLC, TSC, 81-800, 81-810, 81-820, 81-500, 81-510 and 81-511 | X-1232 (proprietary formula) | Package of 5 |
| 80-392 | 80-600, 80-601, 80-651, 80-350, 80-351 and 80-451 | EPDM | Each |

Spray Gun Accessories & Misc. Products

| | |
|---|------------|
| SPRAY GUN CLEANING KITS, BRUSHES & TOOLS | 9-2 |
| SOLVENT SAVER (HOSE GUN CLEANER) | 9-3 |
| SPRAY GUN & PUMP LUBRICANTS / FLUIDS | 9-3 |
| SPRAY GUN ACCESSORIES | 9-4 |
| SPRAY GUN STANDS (GRAVITY FEED GUNS) | 9-6 |
| MISC. PRODUCTS | 9-6 |

Spray Gun Accessories & Misc. Products

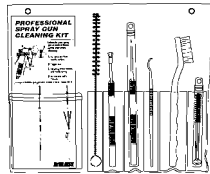

192212

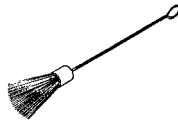

OMX-88



42884-215-K10



42884-214-K5

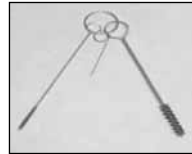

KK-5060



40-3568, 40-3569



DPC-44



WR-103

Spray Gun Cleaning Kits, Brushes & Tools

| Part Number | Description | Notes |
|---------------|--|--|
| 192212 | Professional spray gun cleaning kit | Works for all guns |
| 54-4994 | Gun cleaning kit | Includes: wire tool tip cleaner, 1/4" dia round brush, flat brush |
| OMX-88 | Flat brush | Cleaning brush (semi-rigid) |
| 54-4133 | 1/4" Dia round brush | For cleaning of air & fluid passages |
| 82-469 | 5/8" Dia round brush | For cleaning of air & fluid passages |
| 42884-215-K10 | 5/8" Dia spiral brush | Package of 10, for cleaning of air & fluid passages |
| 42884-214-K5 | 3/8" Dia spiral brush | Package of 5, for cleaning of air & fluid passages |
| DPC-44 | Cleaning brush (DeKups) | For funnels, cups & spray gun passages |
| KK-5060 | Air cap cleaning kit | Includes: wire tool, 1/4" diameter spiral brush, 3/32" diameter spiral brush |
| 40-3568 | Zahn EZ #2 viscosity cup | For measuring viscosity |
| 40-3569 | Zahn EZ #3 viscosity cup | For measuring viscosity |
| 237-707 | 1-80 mil wet film mil gauge | |
| 5-476 | Gun wrench (2100, 21 and 2001) | |
| 54-4213 | Gun wrench (95, 95SL and 95A) | |
| 54-3918 | Gun wrench (Mach 1, Mach 1SL and MI-G) | |
| 73-165 | 11/32" Hex key wrench (7, 18, 2001 gun head removal) | |
| 20-2002 | 1/8" Hex key for 7D and 7E2 needles | |
| 20-1576 | 3/16" Hex key for 43P gun | |
| WR-103 | Gun wrench (DeVilbiss spray guns) | For fluid tips, fittings & bushings |
| SPN-5 | Gun wrench (Compact series) | |
| SRI-50-K2 | Gun wrench (SRI) | |

Spray Gun Accessories & Misc. Products



HD-503, 83GZ-5200

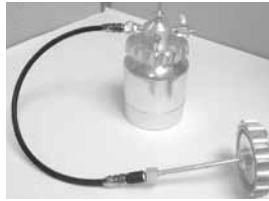

KK-5052
(Lid & cup not included)

Solvent Saver (Hose Gun Cleaner)

| Part Number | Description | Notes |
|-------------|------------------------------|------------------------------------|
| 83GZ-5200 | Solvent saver | 2 Gallons |
| HD-503 | Hose/gun cleaner | 2 Quarts |
| KK-5052 | Adapter fitting and hose kit | For solvent saver & KB series cups |



863009, 42-175, 207-11155, 863020



SSL-10-K12



6-429



0114-009433, 0114-014871

Spray Gun & Pump Lubricants / Fluids

| Part Number | Description |
|-------------|--|
| 41-3134 | Binks Pump Purge, case of 12 |
| 41-4458-K | PTFE grease (Magna Lube) .75 oz. tube |
| 44-285 | 14 oz. grease cartridge – fits standard grease guns |
| 863009 | Wet-Sol upper pump packing lubricant 1 quart |
| 42-175 | Pump packing lubricant 1 quart |
| 863020 | Air line lubricant 1 quart |
| 207-11155-1 | Air motor lubricant 2 oz |
| 207-11155-2 | Air motor lubricant 16 oz |
| 0114-009433 | Pump packing lube for solvent based materials, MX series pumps |
| 0114-014871 | Pump packing lube for water based materials, MX series pumps |
| SSL-10-K12 | Devilbiss gun lube 12 ea 2 oz bottles |
| 6-429 | Binks Gunners Mate gun lube 20 ea 2 oz bottles |

Spray Gun Accessories & Misc. Products



JGA-444

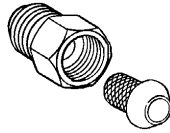

PLH-MF-6-100



VS-531



54-990, 54-991



54-2831



54-3691, GC-100-K4,
GC-100-K48

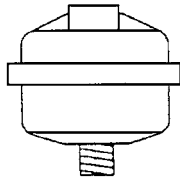

HAF-507-K12



AGA-414



AGA-415



54-380

Spray Gun Accessories

| Part Number | Description |
|--------------|---|
| JGA-444 | Fluid tube (JGA spray guns) |
| VA-532 | Inlet strainer (JGA spray guns) |
| 54-957 | Fluid inlet tube (95, 95SL, Mach 1, Mach 1SL, 2001) |
| 54-982 | Fluid strainer assembly, 150 mesh (95, 95SL, Mach 1, 2001) |
| 54-988 | Fluid strainer assembly, 100 mesh (95, 95SL, Mach 1, 2001) |
| PLH-MF-6-100 | S.S. fluid strainer assembly, 100 mesh, 3/8" nps(m) x 3/8" nps(f) |
| VS-531 | Fluid inlet strainer, 100 mesh |
| 54-990 | Fluid inlet strainer, 100 mesh |
| 54-991 | Fluid inlet strainer, 150 mesh |
| 54-2831 | Striping spray shield (replaces 54-372 ring) |
| 54-3691 | Gun covers for automatic spray guns (20/pkg.) |
| GC-100-K4 | Gun covers for manual spray guns (4/pkg.) |
| GC-100-K48 | Gun covers for manual spray guns (48/pkg.) |
| HAF-507-K12 | Whirlwind air filter gun mount (12/pkg.) |
| AGA-414 | Gun mounting stud/rod (automatic spray guns) |
| AGA-415 | Universal clamp (automatic spray guns) |
| 54-380 | Gun bracket (automatic spray guns) |

Spray Gun Accessories & Misc. Products



HAV-500



HAV-501



P-H-5516



HARG-510

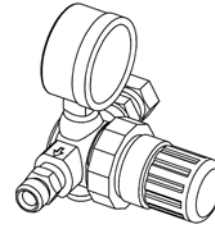

85-441

Spray Gun Accessories

| Part Number | Type | Inlet Size | Outlet Size | W or W/O Gauge Assy. | Max. Working Pressure | Recommended Range | Service Form |
|-------------|-----------|------------|-------------|----------------------|-----------------------|-------------------|--------------|
| 873409 | Straight | 1/4"npt(f) | 1/4"npt(f) | W/O | 100 psi | 0-100 psi | n/a |
| HAV-500 | Straight | 1/4"nps(m) | 1/4"nps(f) | W/O | 125 psi | 0-125 psi | SB-11-119 |
| HAV-501 | Straight | 1/4"nps(m) | 1/4"nps(f) | W / Gauge | 125 psi | 0-125 psi | SB-11-119 |
| 73-159 | 90 Degree | 1/4"nps(m) | 1/4"nps(f) | W/O | 250 psi | 0-125 psi | n/a |
| P-H-5516 | 45 Degree | 1/4"nps(m) | 1/4"nps(f) | W/O | 250 psi | 0-125 psi | SB-11-119 |
| HARG-510 | Regulator | 1/4"nps(m) | 1/4"nps(f) | W / Gauge | 300 psi | 0-160 psi | SB-6-105 |
| 85-441 | Regulator | 1/4"nps(f) | 1/4"nps(m) | W / Gauge | 300 psi | 0-50 psi | 77-2825 |

Spray Gun Accessories & Misc. Products

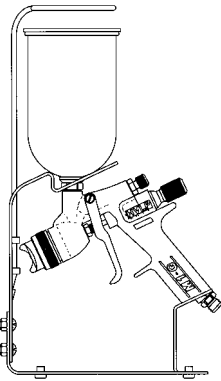

54-4350

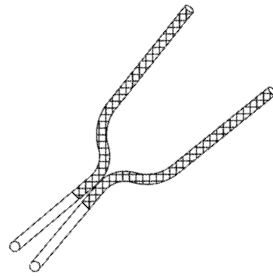

192219

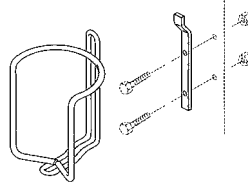

GH-407

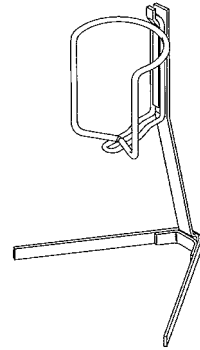

GH-505

Spray Gun Stands (Gravity Feed Guns)

| Part Number | Description | Notes |
|-------------|----------------------------|------------|
| 54-4350 | Gun stand for gravity guns | Bench top |
| 192219 | Gun holder | Wall mount |
| GH-407 | Gun holder | Wall mount |
| GH-505 | Gun stand assembly | Bench top |



6580-0000-1

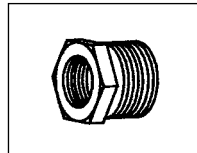

49-1834



MSVAD-416

Misc. Products

| Part Number | Description |
|-------------|--|
| 6580-0000-1 | Model 190 dusting gun with 60-40 nozzle |
| 6580-6041-0 | Model 190 dusting gun with 60-41 nozzle extension 5-1/2" long |
| 49-1834 | Adapter fitting 3/4"-20 female x 7/8"-14 male (F thread to G thread) used to convert typical threads for tip extensions, tip bases, etc. |
| MSVAD-416 | Polyethylene hose sleeve, 100 ft |
| 54-1439 | Tip seal – use with 49-1839 adapter |
| 41-661 | 5 gallon steel pail |



Sales and Service Through A Global Network of Industrial Distributors

North American Office
ITW Industrial Finishing
195 Internationale Blvd.
Glendale Heights, IL 60139 USA
630-237-5000

Toll Free Customer Support
800-992-4657 USA & Canada Only